



VIVAN
cornici

www.vivan.it

MADE 
IN
ITALY 

CATALOGO CORNICI

ITALIAN DESIGN & PRODUCTION

La VIVAN CORNICI
è lieta di presentarvi il suo
nuovo catalogo, uno strumento
utile alle vostre esigenze che
segue le tendenze di un mondo
in continuo cambiamento.

VIVAN CORNICI is pleased to present its new catalogue, a useful tool for your needs that follows the trends of a constantly changing world.

THE BEST OF

MADE
IN
ITALY



Coniugando arte, colore e differenti stili cerchiamo di offrirvi un sapere artigiano che si tramanda oramai da più di quarant'anni.

Il nostro impegno per l'ambiente ci ha portato nel tempo ad essere autosufficienti al 100% per quanto riguarda il fabbisogno termico e al 70% per quello energetico.

Rimanendo fedeli al MADE IN ITALY possiamo inoltre garantirvi una produzione svolta completamente all'interno dell'azienda, assicurando così uno standard di qualità elevato che ci viene riconosciuto ancora oggi da affezionati clienti in Italia e all'estero.

Un magazzino sempre rifornito riesce a sostenere in ogni momento consegne rapide e puntuali.

Combining art, colour and different styles we try to offer you an artisan know-how that has been handed down for more than forty years.

Our commitment to the environment has led us over time to be 100% self-sufficient in terms of heating requirements and 70% in terms of energy.

Remaining faithful to the MADE IN ITALY we can also guarantee you a production carried out completely within the company, thus ensuring a high quality standard that is still recognized today by loyal customers in Italy and abroad.

An always stocked warehouse is able to support rapid and punctual deliveries at all times.

Quando il lavoro diventa passione, grazie alle energie e al tempo che vi dedichiamo, i risultati si vedono nella soddisfazione dei nostri clienti: l'inesauribile motore che ci spinge a fare sempre meglio.

When work becomes passion, thanks to the energy and time we dedicate to it, the results can be seen in the satisfaction of our customers: the inexhaustible engine that drives us to do better and better.



0231 / 86

0231 / 87

0231 / 88

0231 / 89

0231 / 90

0231 / 92

0231 / 93

0231 / 94

0231 / 95

0231 / 97

0231 / 99



0231 / 91 0231 / M91 0231 / 98

0233 / 81 0233 / 91

0233 / 86 0233 / 87

0233 / 88 0233 / 89

0233 / 90 0233 / 92

0233 / 516 0233 / 525

0233 / 528

0231 / 81 0231 / 40 0231 / 516

0233 / M91 0233 / 40

0233 / 212 0233 / 211

0233 / 209 0233 / 206

0233 / 205 0233 / 204

0233 / 39 0233 / 01

0233 / 00

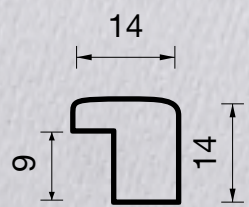

Art. 0231

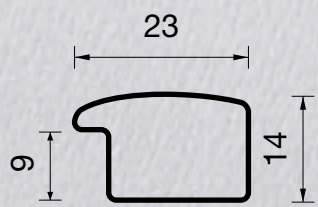

Art. 0233

0233 / 3 0233 / 4 0233 / 5A 0233 / 6A



23 / 52

23 / 57

23 / 53

23 / 59

23 / 55

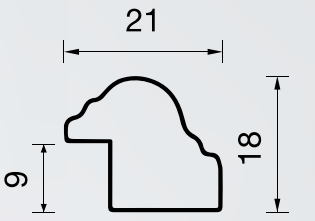

Art. 24

24 / 204

23 / 70

23 / 54

24 / 203

24 / 205

23 / 71

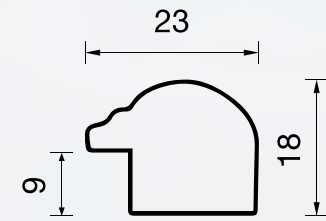

Art. 23

24 / 31

24 / 206

23 / 72

24 / 5A

24 / 209

23 / 73

23 / 31

24 / 6A



10 / B / 4



10 / B / 3



10 / B / 39



10 / B / 00



10 / B / 91



10 / B / 40

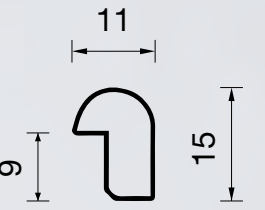

Art. 10/B



13 / 201



13 / 31

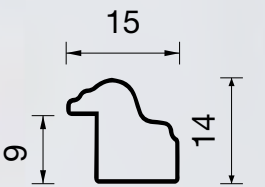

Art. 13



13 / 204



13 / 203



13 / 209



13 / 206



13 / 205

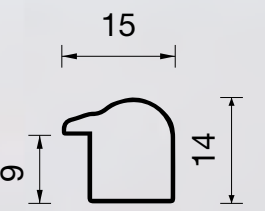

Art. 19



19 / 71



19 / 31



19 / 9

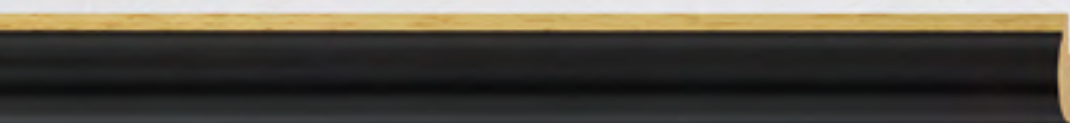

19 / 91



19 / 74



19 / 72

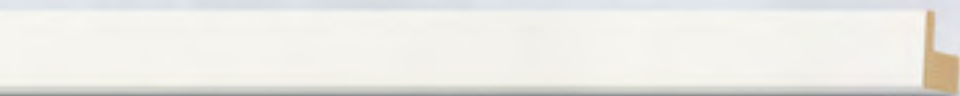

10 / 40



10 / 39



10 / 00

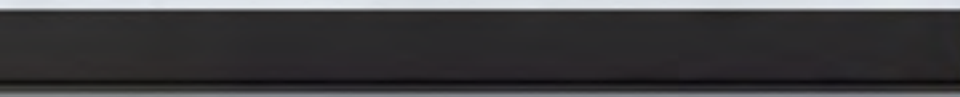

10 / M91



10 / 506



10 / 505

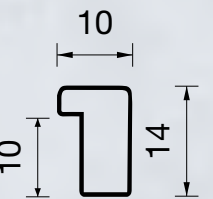

Art. 10



15 / 39

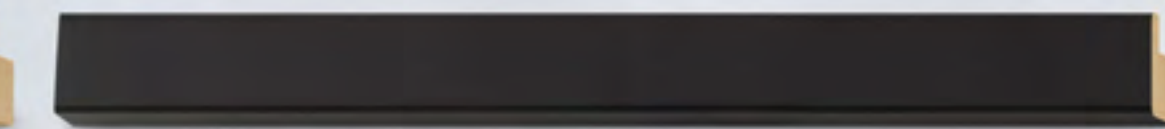

15 / S91



15 / 40

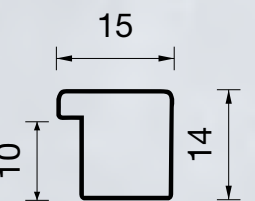

Art. 15



15 / 506



15 / 505



15 / 01



15 / 00



21 / 91



21 / 81

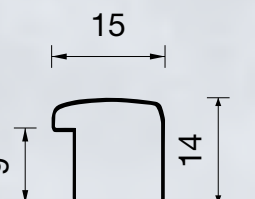

Art. 21



21 / 87



21 / 86



21 / 90



21 / 89



21 / 88



21 / 4



21 / 3



21 / 6A



21 / 5A



20 / 39

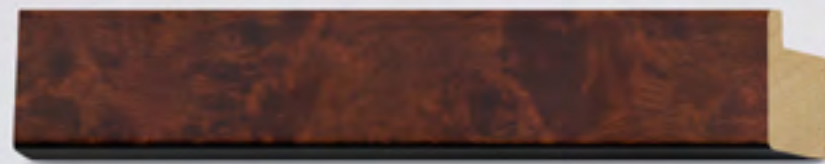

20 / 28



20 / 26



20 / 00



20 / 506



20 / 505

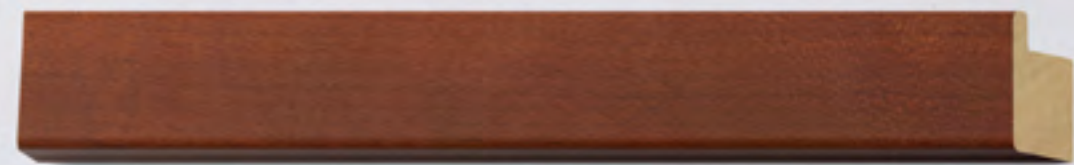

20 / 80



20 / 205



20 / 204



20 / 203



20 / 211

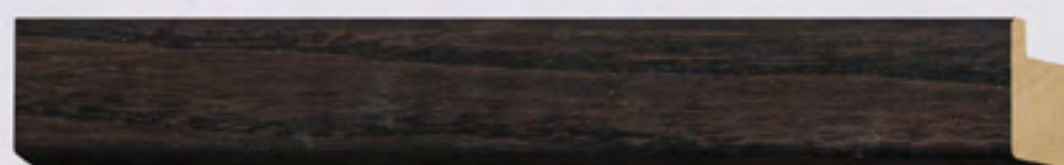

20 / 208



20 / 206



20 / M85



20 / 230



20 / 214

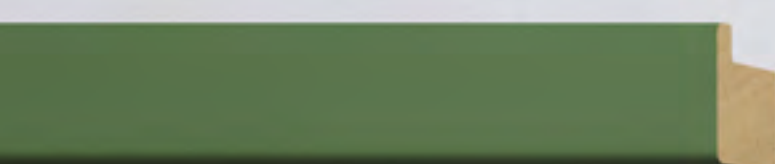

20 / M87



20 / M86

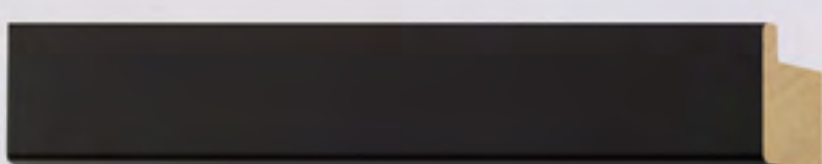

20 / s91

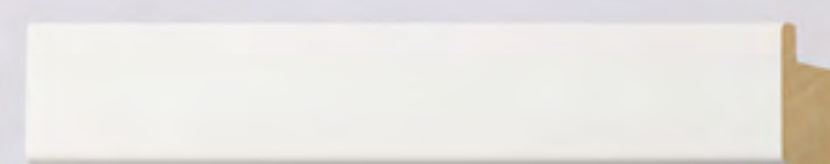

20 / 40



20 / M92

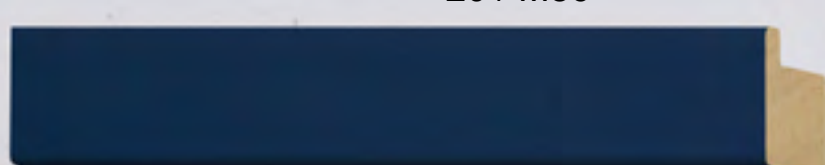

20 / M90



20 / M89

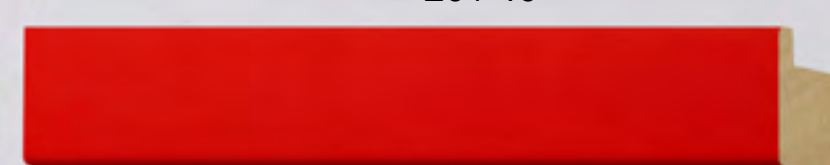

20 / M88

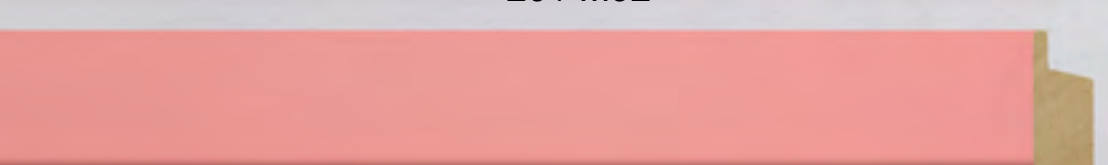

20 / M95

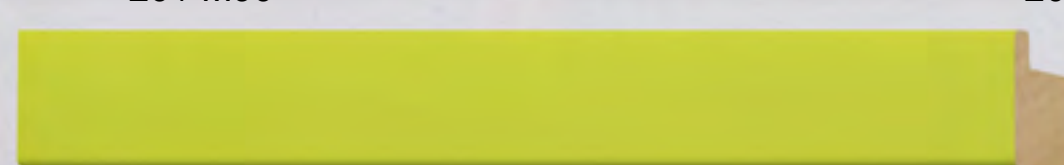

20 / M94

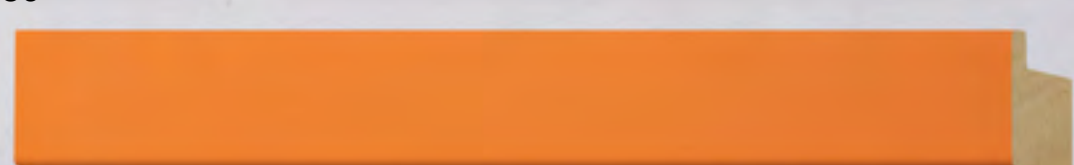

20 / M93

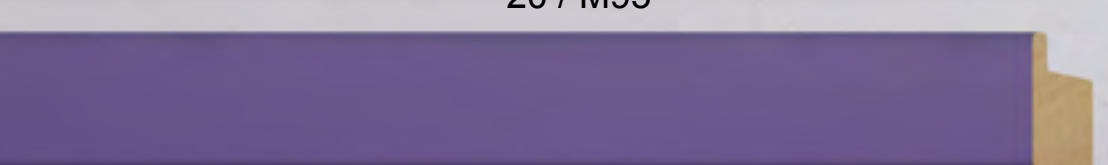

20 / M99



20 / M98



20 / M97

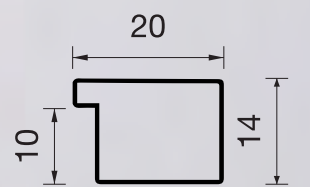

Art. 20

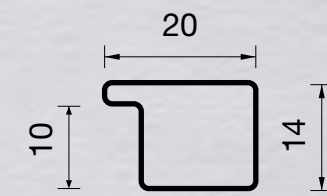

Art. 083

083 / 4

083 / 3

0189 / 40

083 / 5

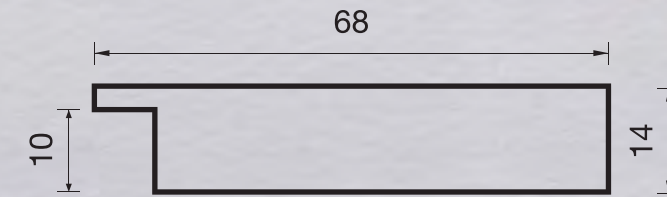

Art. 0189

0189 / 3

0189 / M91

0189 / 00

0189 / 5

0189 / 91

0189 / 39

0189 / 4

0189 / 81



40 / 39



40 / 00

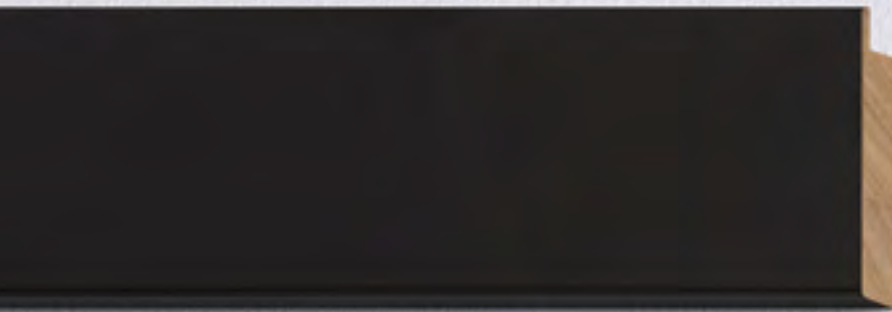

40 / M91

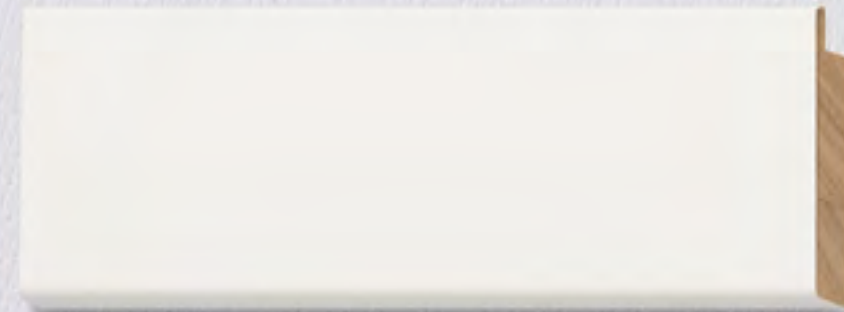

40 / 40

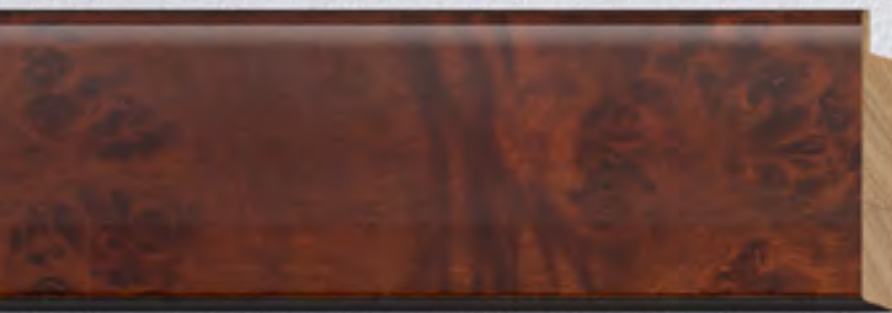

40 / 26



40 / 80



40 / 28

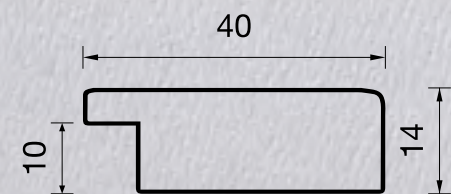

Art. 40

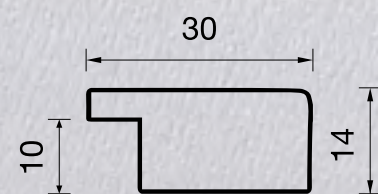

Art. 30



30 / 505

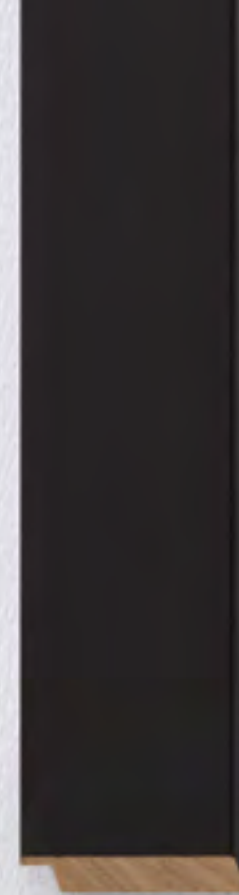

30 / S91



30 / 39



30 / 00



30 / 28



30 / 506

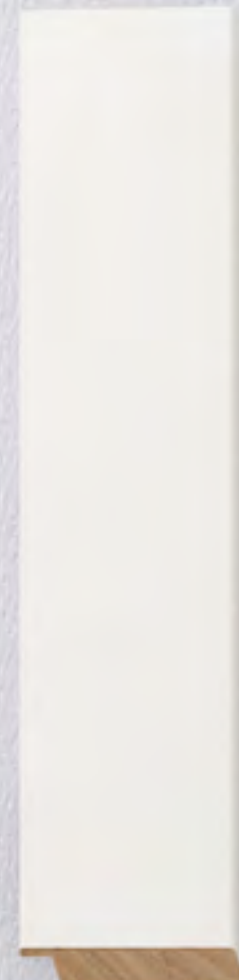

30 / 40



30 / 80



30 / 00



30 / 26



25 / 4



25 / 3

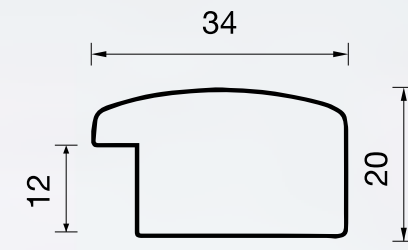

Art. 25



27 / 4



27 / 3

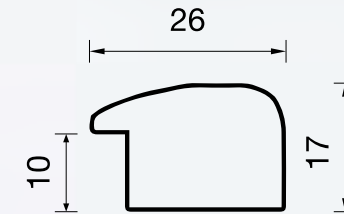

Art. 27



495 / 4



495 / 3

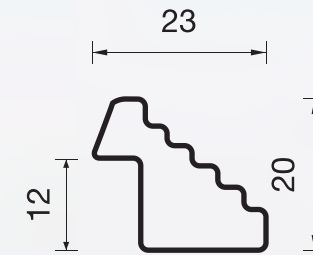

Art. 495



495 / M98



495 / M91



495 / 40

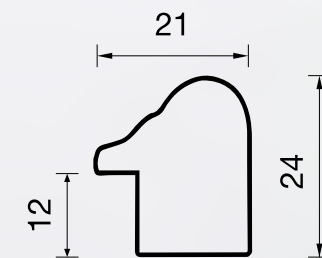

Art. 70



70 / 704



70 / 705



70 / 706



70 / 13



70 / 715



70 / 717



70 / 31



70 / 91



70 / 14

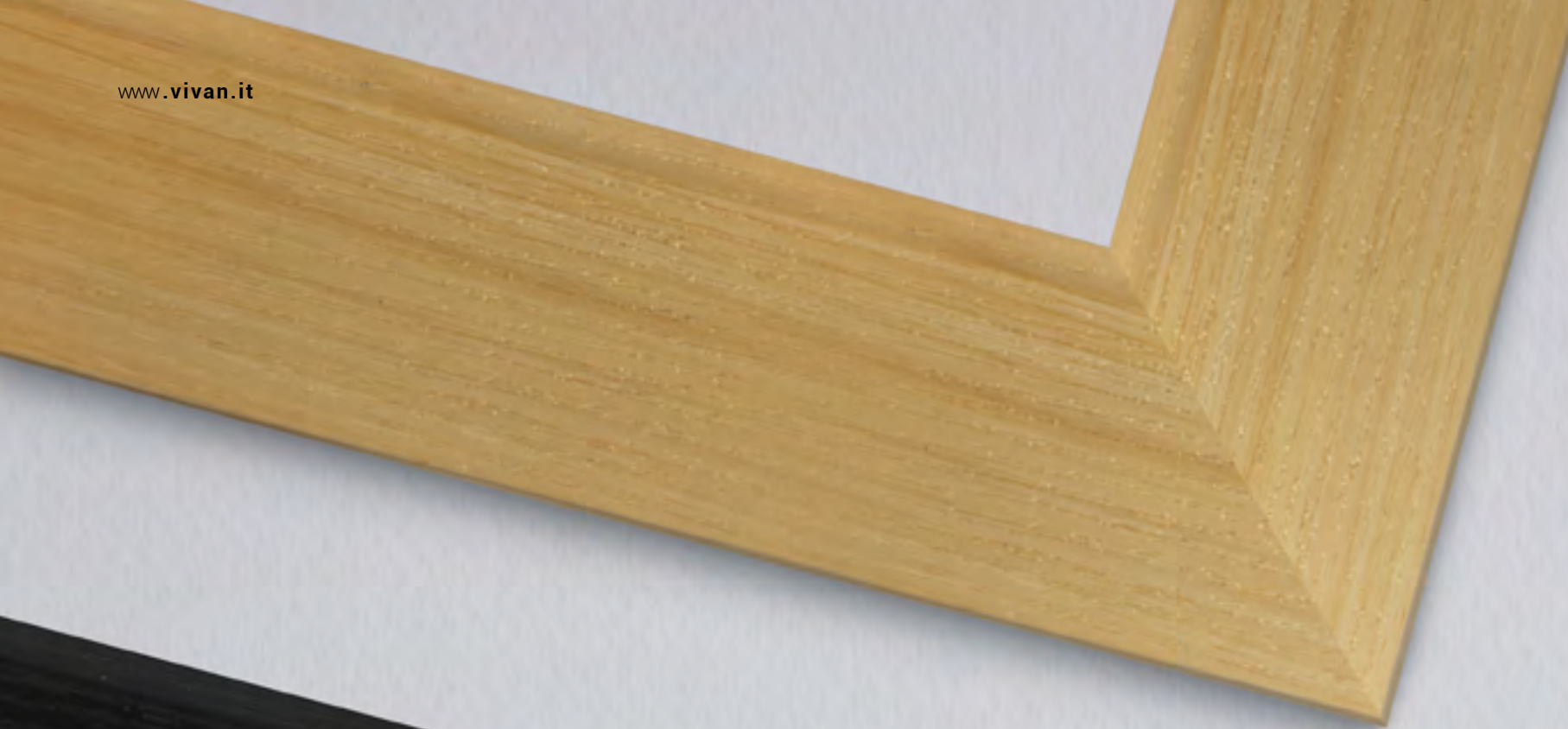

163 / 39



48 / 40



48 / s91



48 / 614



48 / 608



163 / 608

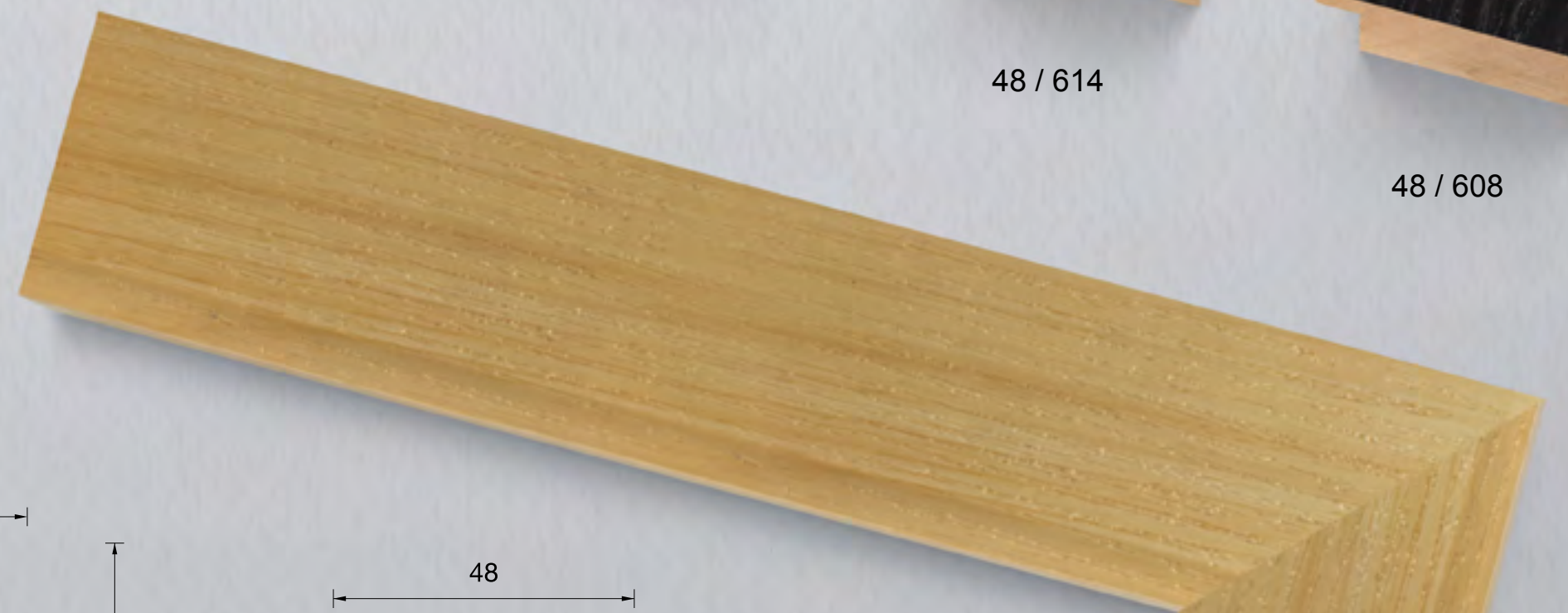

48 / 39



163 / 614

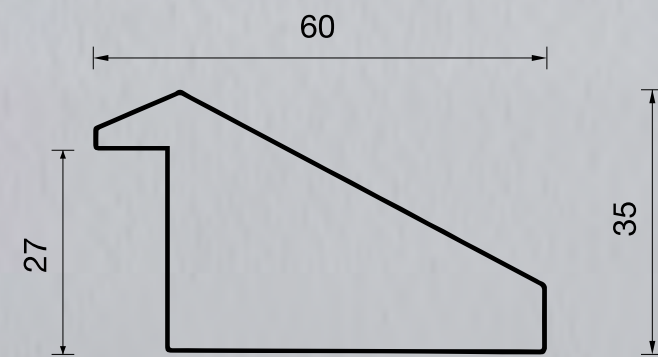

Art. 163

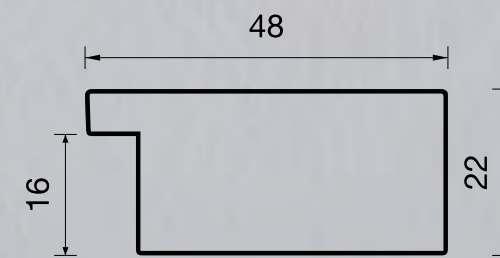

Art. 48



58 / 805



58 / 804



58 / 802



58 / 815



58 / 811



58 / 806

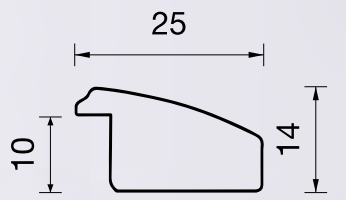

Art. 58

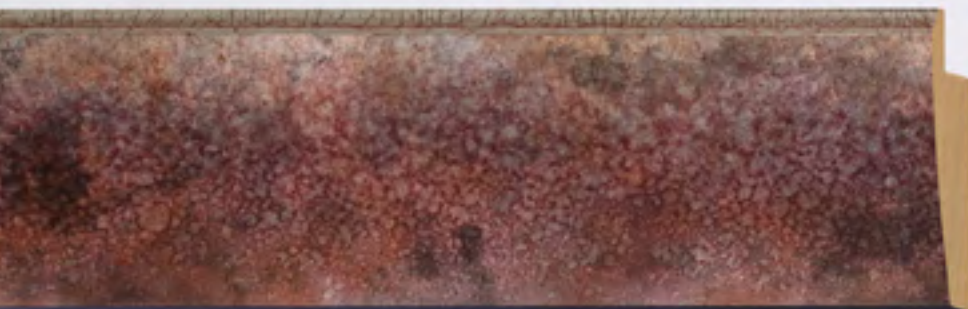

59 / 805

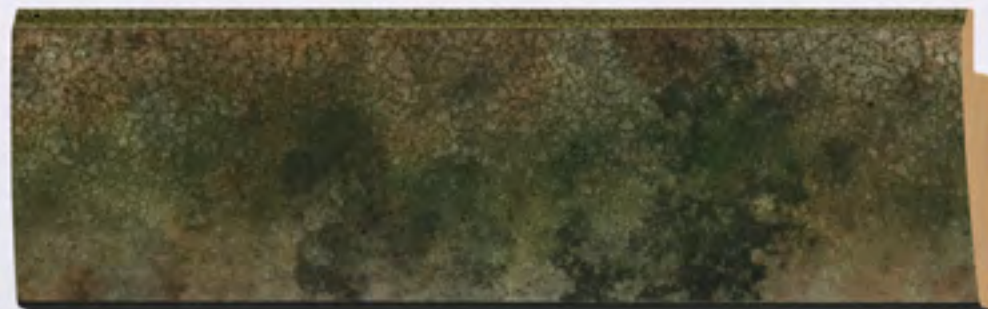

59 / 804

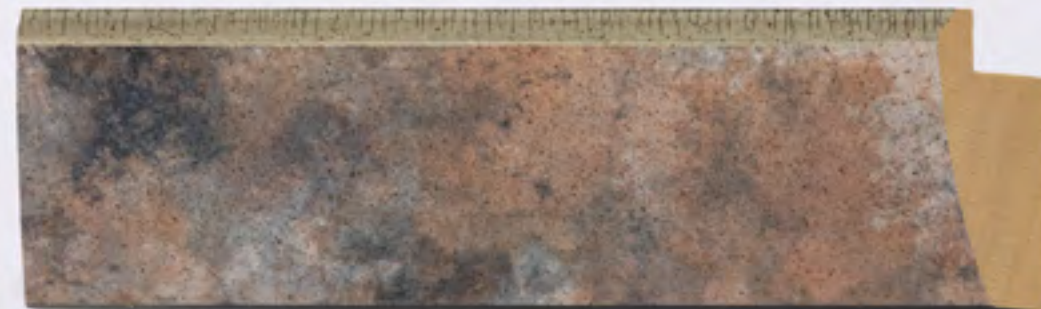

59 / 802

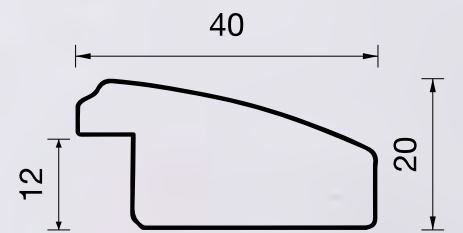

Art. 59



59 / 815



59 / 811



59 / 806



162 / 706



162 / 704



62 / 705



62 / 716



162 / 715



162 / 705

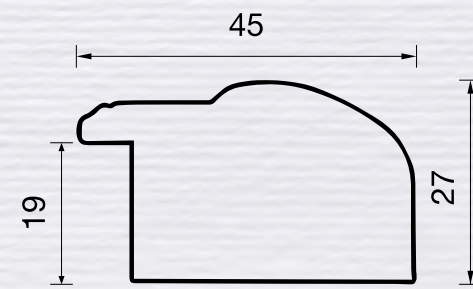

Art. 62



62 / 704



62 / 715



162 / 716



162 / 312

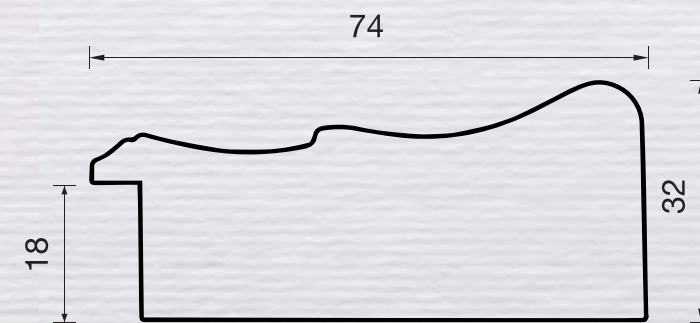

Art. 162

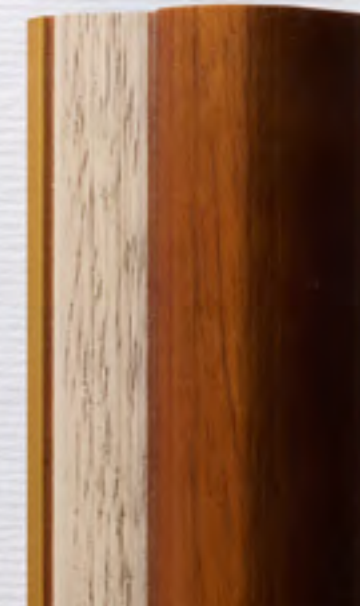

62 / 312



62 / 706

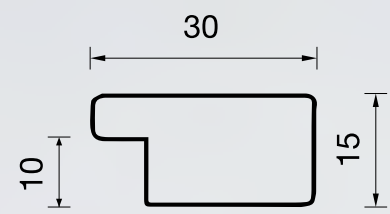

Art. 300



300 / 604



300 / 605



300 / 606



300 / 611



300 / 614



300 / 3



300 / 4



300 / 618



300 / 619



18 / 102



18 / 104



18 / 105

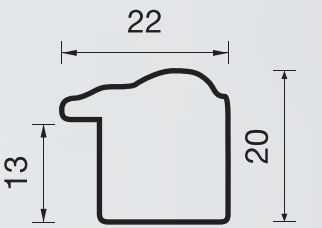

Art. 18



18 / 106



18 / 107



18 / 109



18 / 111



35 / 00 35 / 31



36 / 00 36 / 31



37 / 00 37 / 31



52 / 31B 52 / 33



53 / 31B 53 / 33

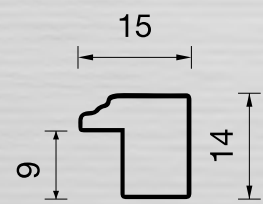

Art. 35

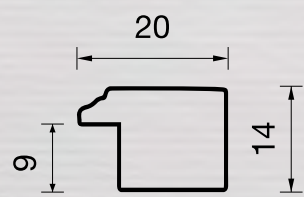

Art. 36

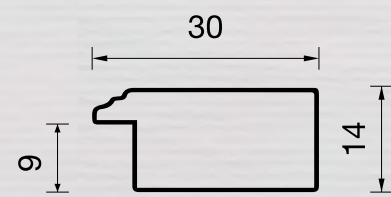

Art. 37

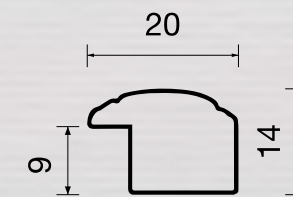

Art. 52

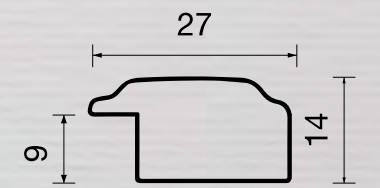

Art. 53



0624 / 91



0624 / 71



0624 / 31

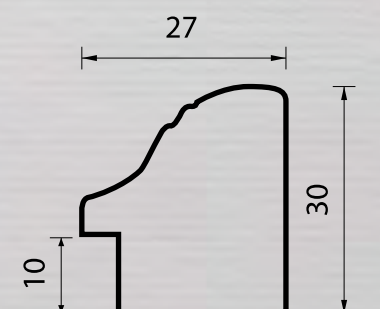

Art. 0624



350 / 33B

350 / 31B



550 / 33B



550 / 31B



450 / 33B



450 / 31B



240 / 330



0363 / 330



0366 / 330

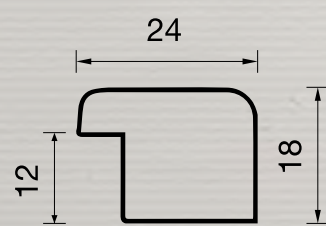

Art. 240

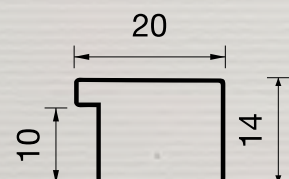

Art. 0363

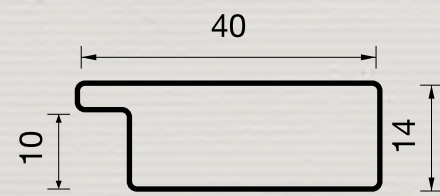

Art. 0366

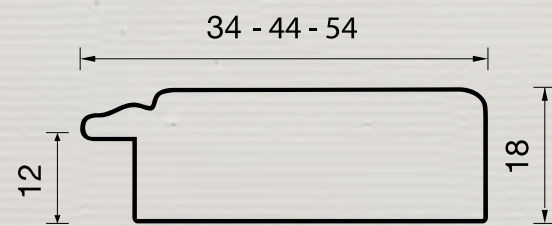

Art. 350 - 450 - 550



700 / 200

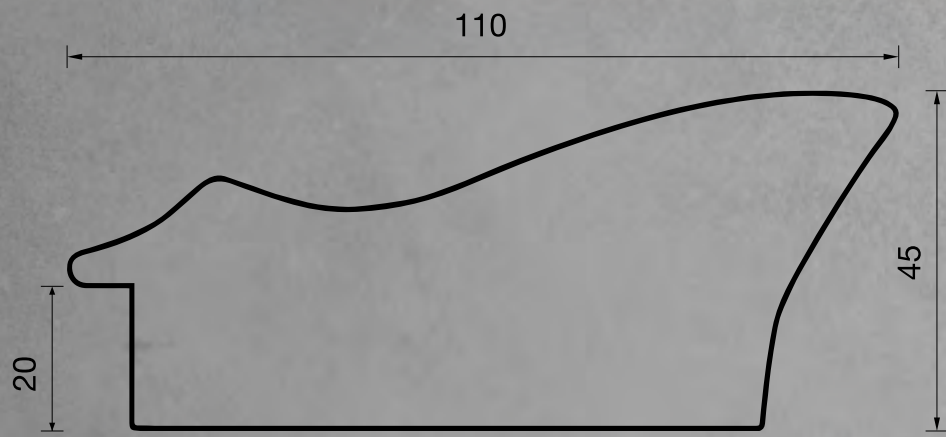

Art. 700



167 / 200

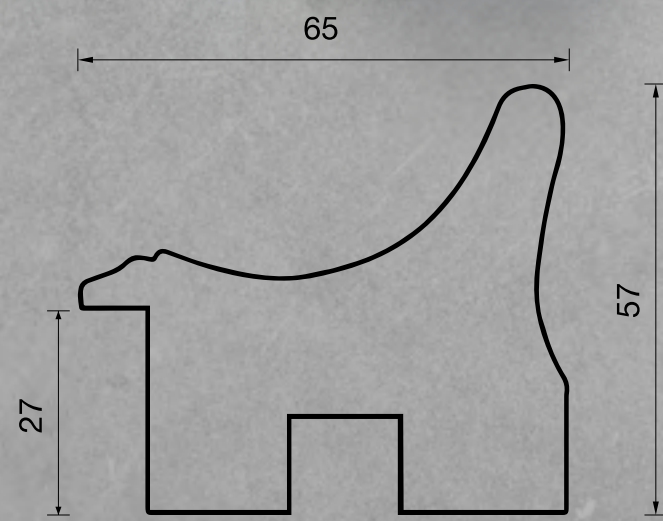

Art. 167



163 / 207



163 / 200



460 / 200



460 / M91



460 / 40



113 / 200

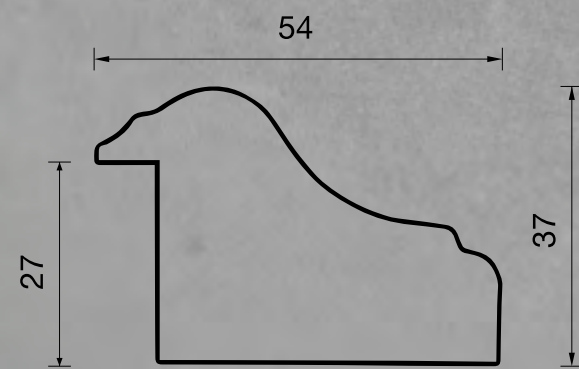

Art. 113

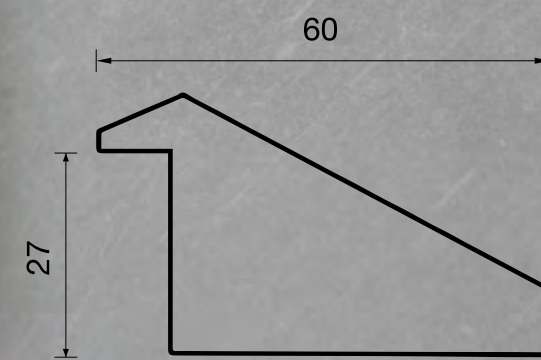

Art. 163

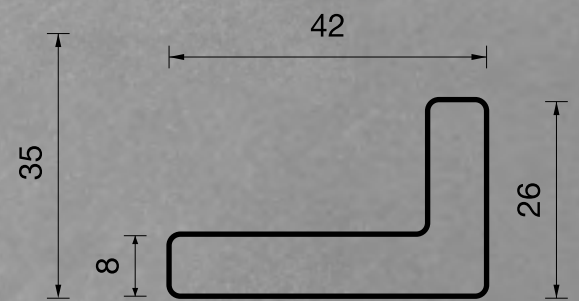

Art. 460

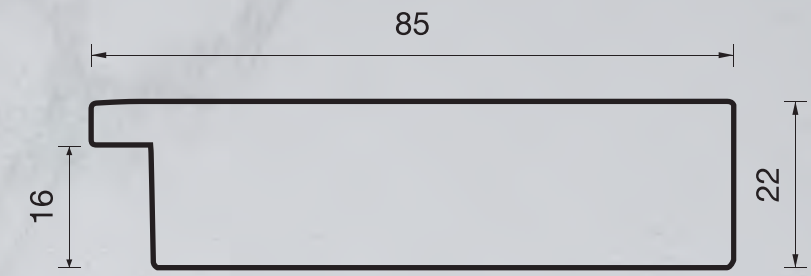

Art. 85

32 / 207

32 / 200

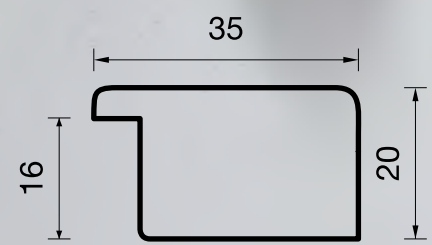

Art. 32

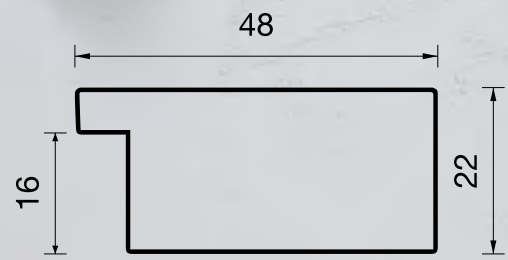

Art. 48

48 / 801

48 / 200

48 / 800

85 / 801

85 / 800

85 / 200

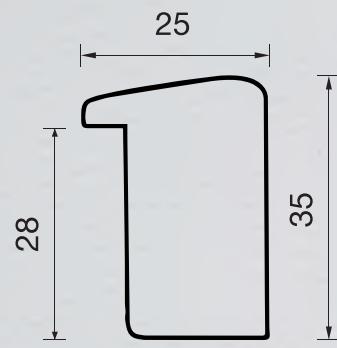

Art. 323



323 / 61 323 / 62 323 / 5A 323 / 6A 323 / 516

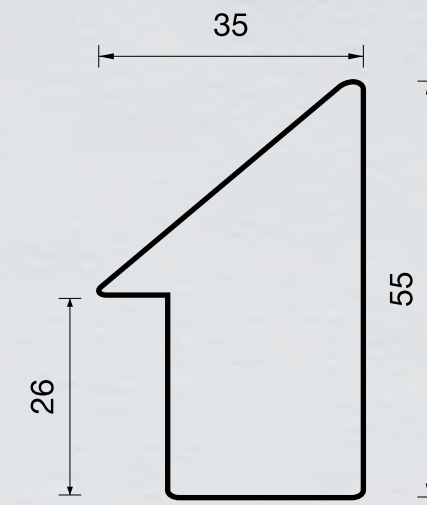

Art. 590

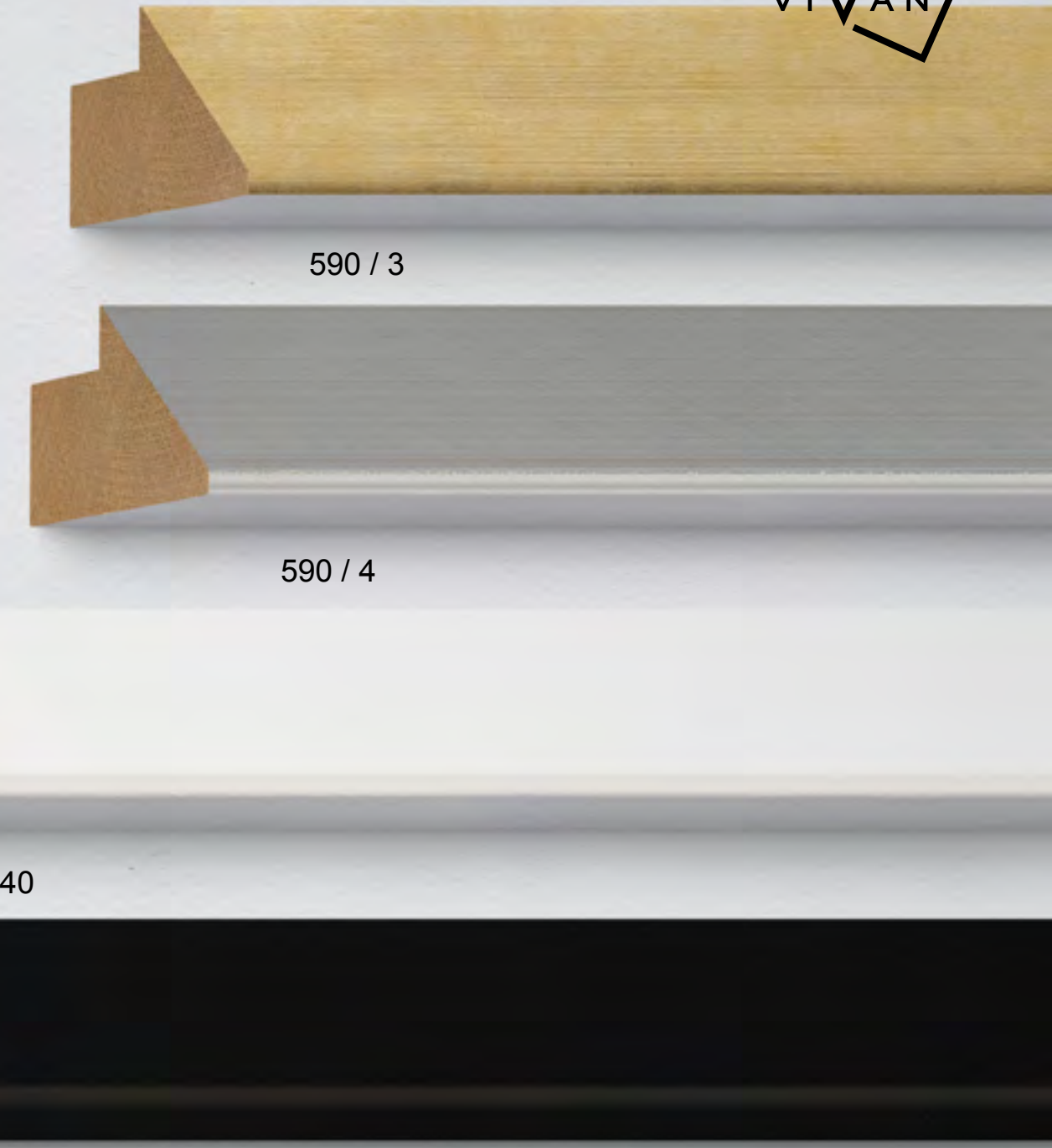

590 / 3
590 / 4
590 / 40
590 / M91

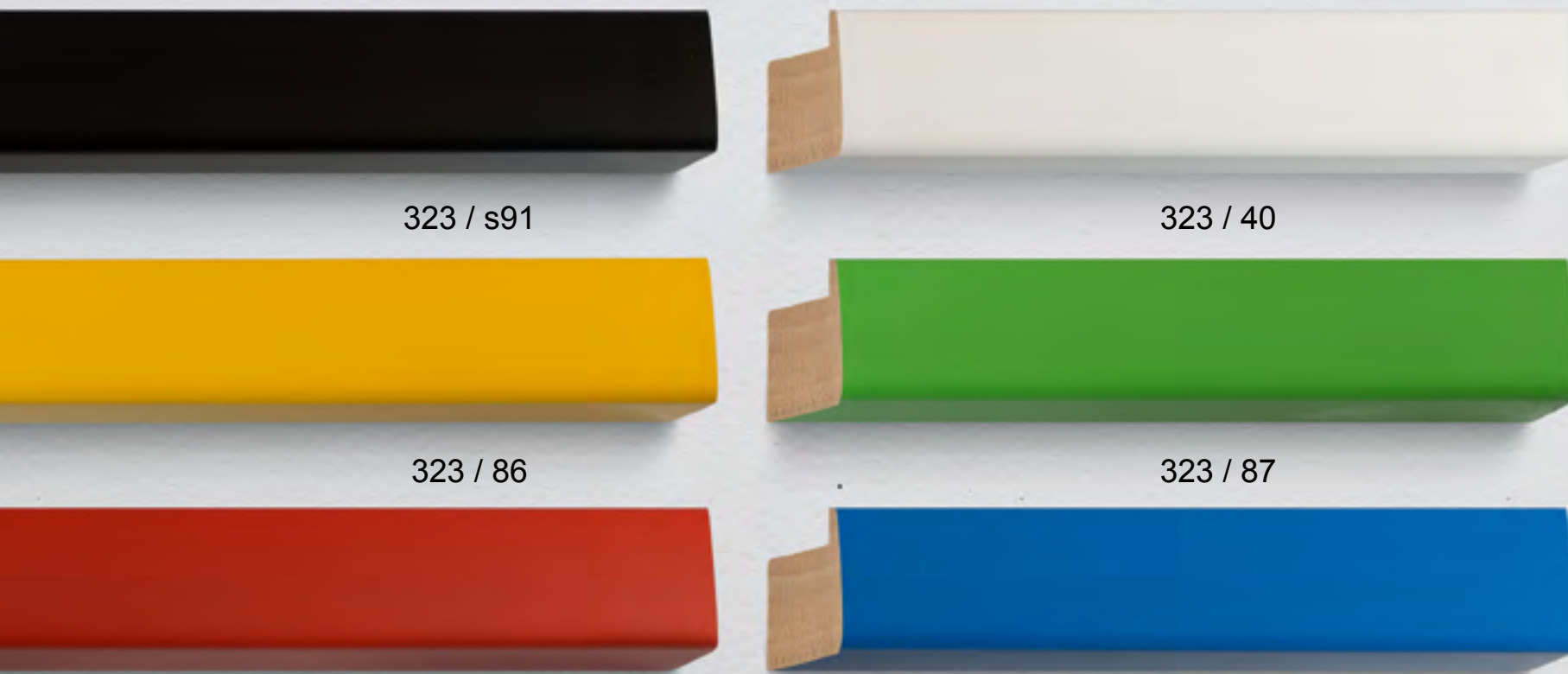

323 / s91 323 / 40
323 / 86 323 / 87
323 / 88 323 / 90

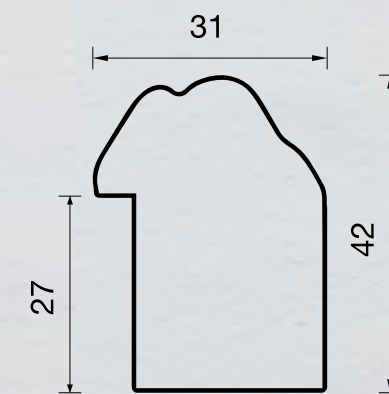

Art. 94



94 / 65
94 / 66



12 / 3 12 / 4 12 / 00 12 / 39 12 / 40 12 / s91

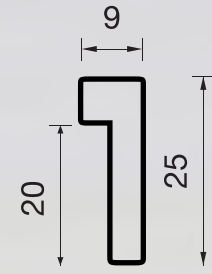

Art. 12

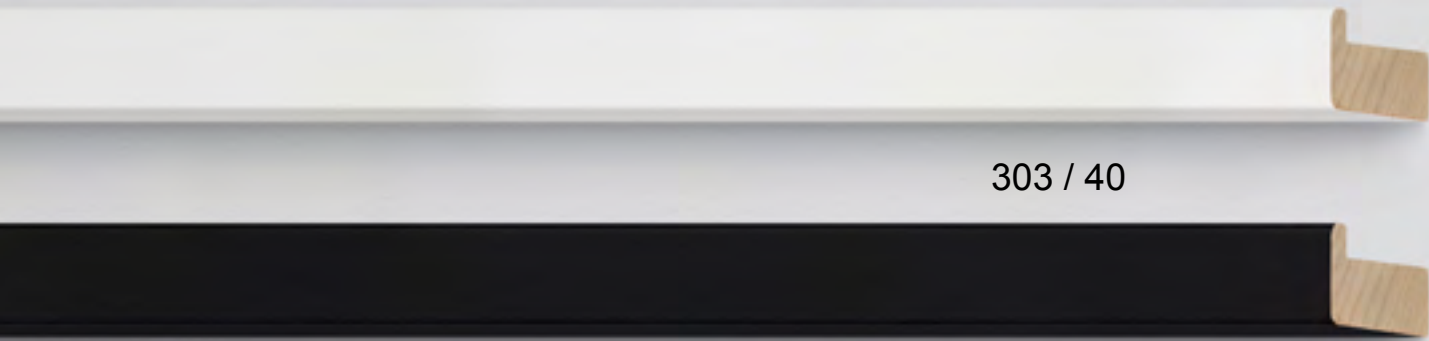

303 / 40

303 / M91

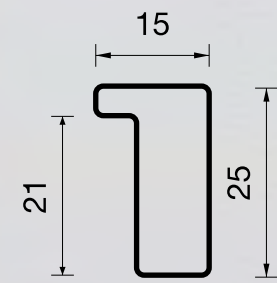

Art. 303

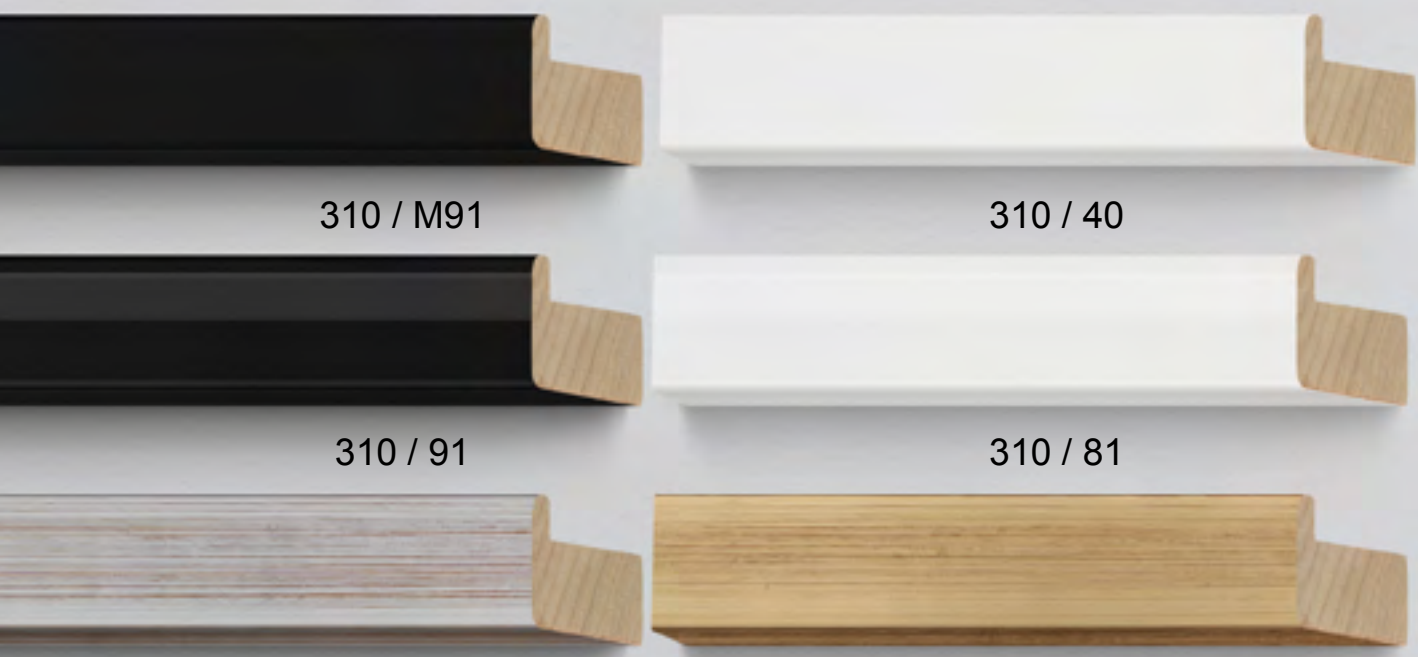

310 / M91

310 / 40

310 / 91

310 / 81

310 / 506

310 / 505

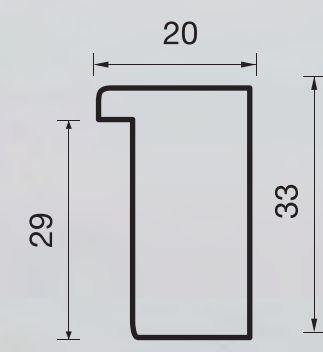

Art. 310

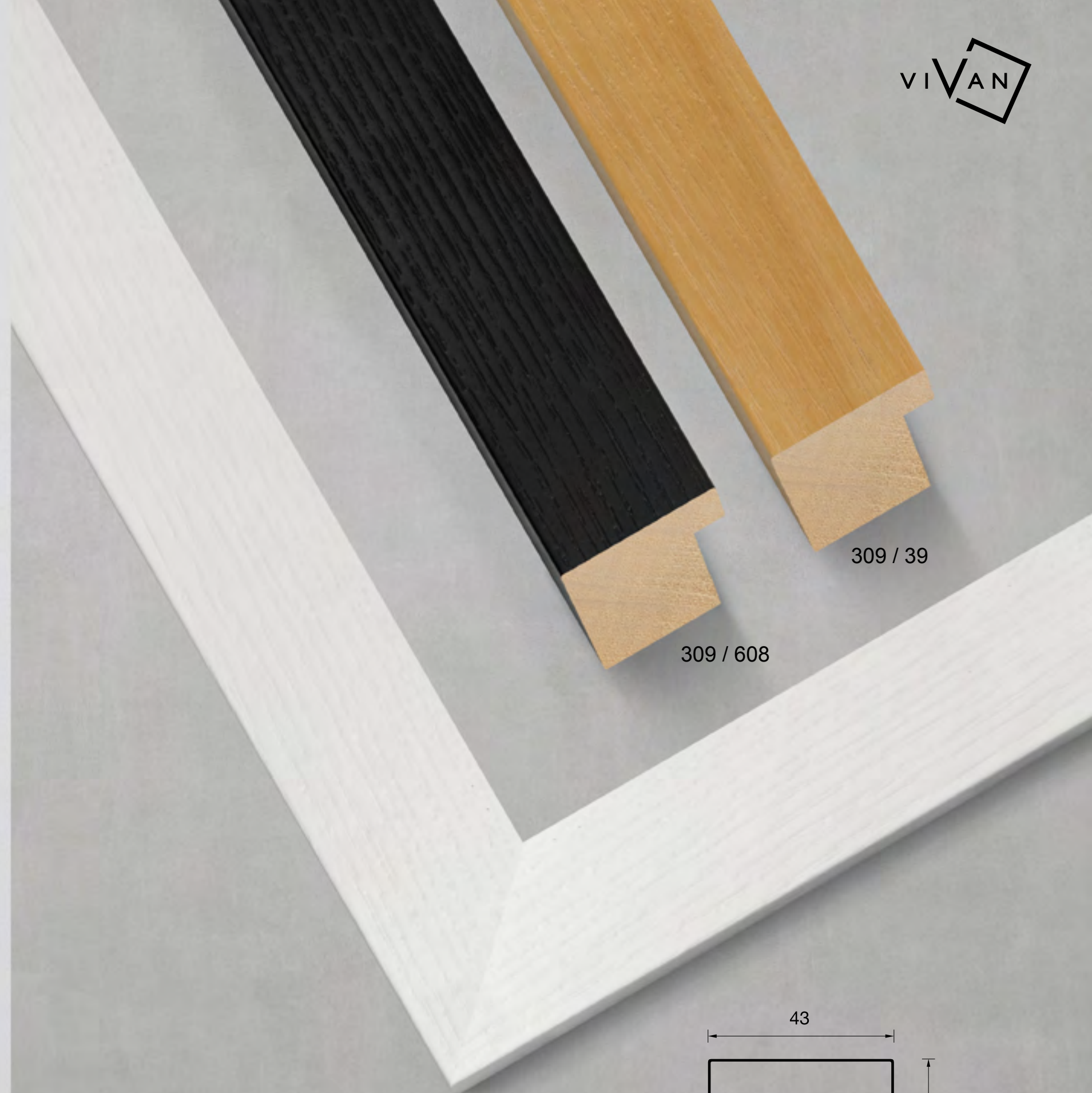

309 / 39

309 / 608

309 / 614

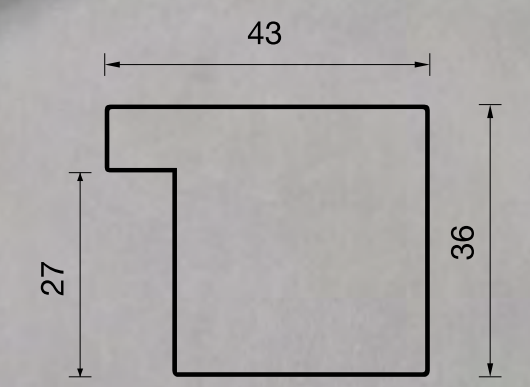

Art. 309

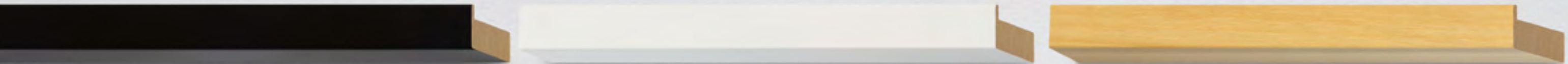

305 / M91

305 / 40

305 / 39

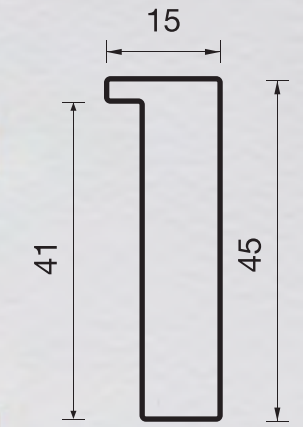

Art. 305



306 / 4

306 / 3

306 / 00

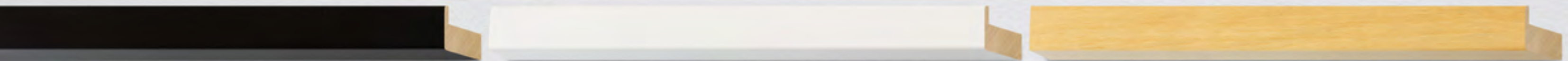

306 / s91

306 / 40

306 / 39

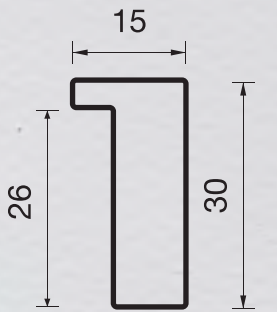

Art. 306



307 / 4

307 / 3

307 / 01

307 / 00

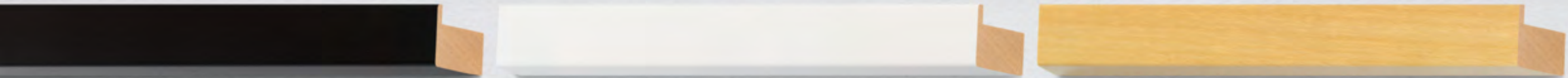

307 / s91

307 / 40

307 / 39

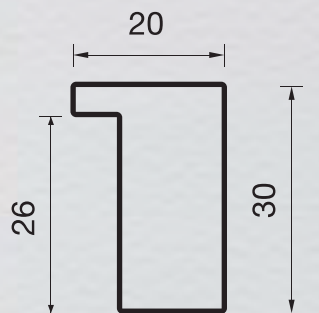

Art. 307



307 / 211

307 / 206

307 / 205

307 / 204



307 / 203

307 / 230

307 / 214

307 / 208

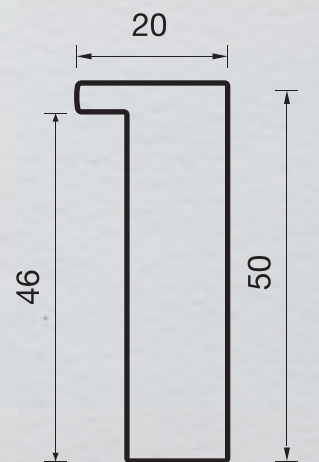

Art. 0006



0006 / s91

0006 / 40



490 / M85



490 / M86



490 / M87



490 / M88



490 / M89



490 / M90



490 / M98



490 / 40

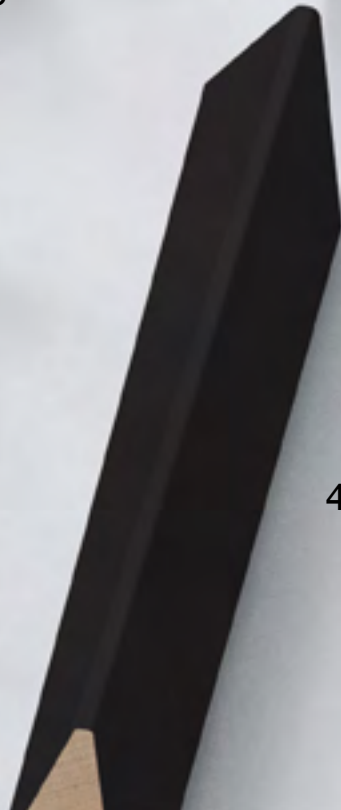

490 / M91

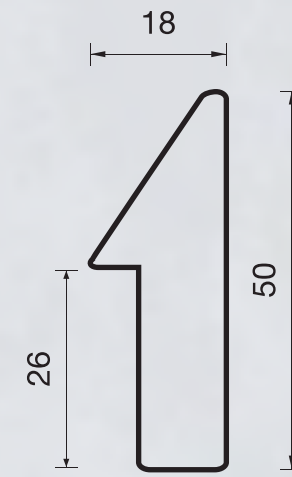

Art. 490



490 / M92



490 / M93

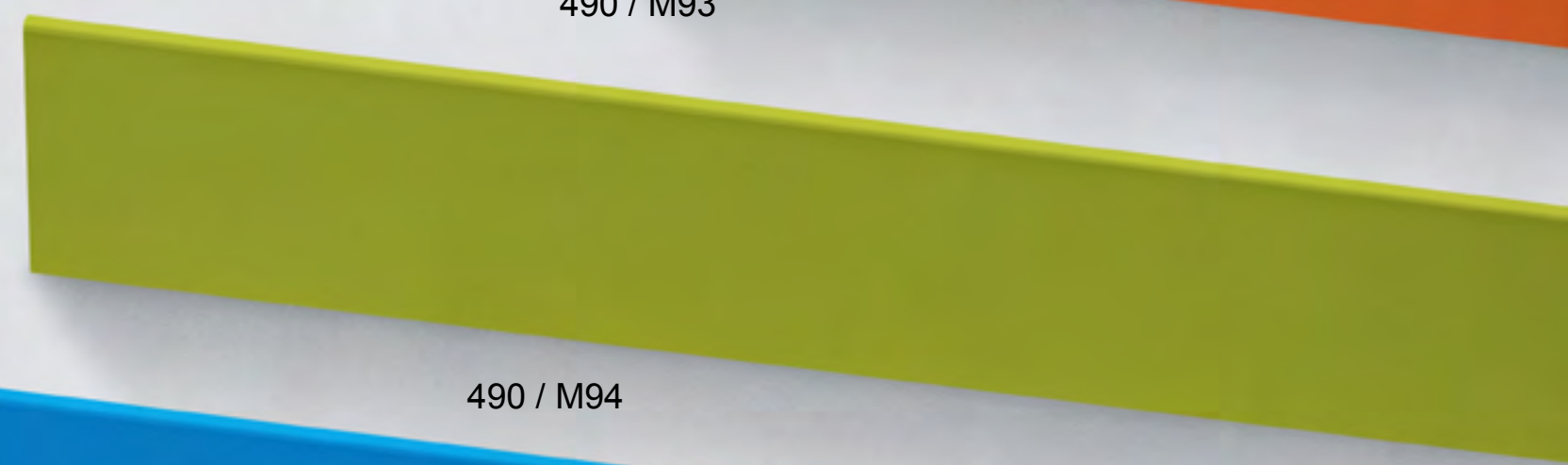

490 / M94



490 / M97



490 / M99

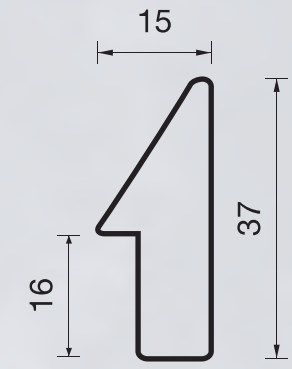

Art. 470

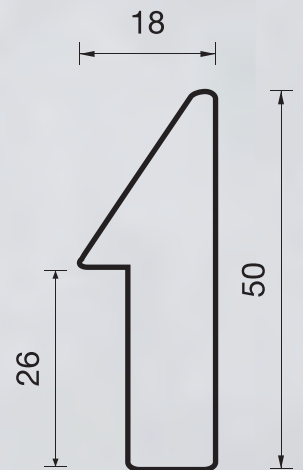

Art. 490

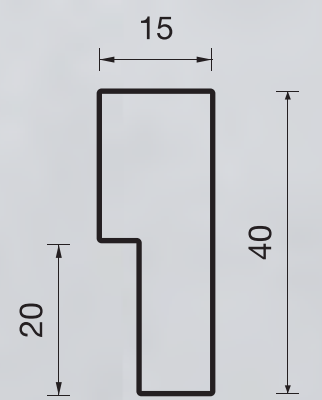

Art. 500

490 / 203

470 / 203

470 / 208

470 / 214

490 / 208

490 / 214

500 / 203

500 / 208

500 / 214

500 / 40

500 / M87

500 / M86

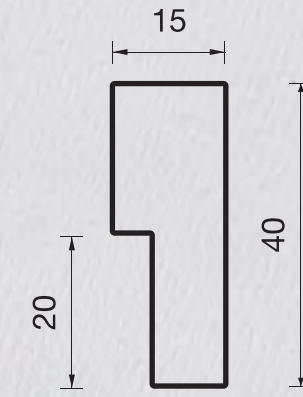

Art. 500

500 / M85

500 / M90

500 / M89

500 / M88

500 / M93

500 / M92

500 / M91

500 / M99

500 / M98

500 / M97

500 / M94

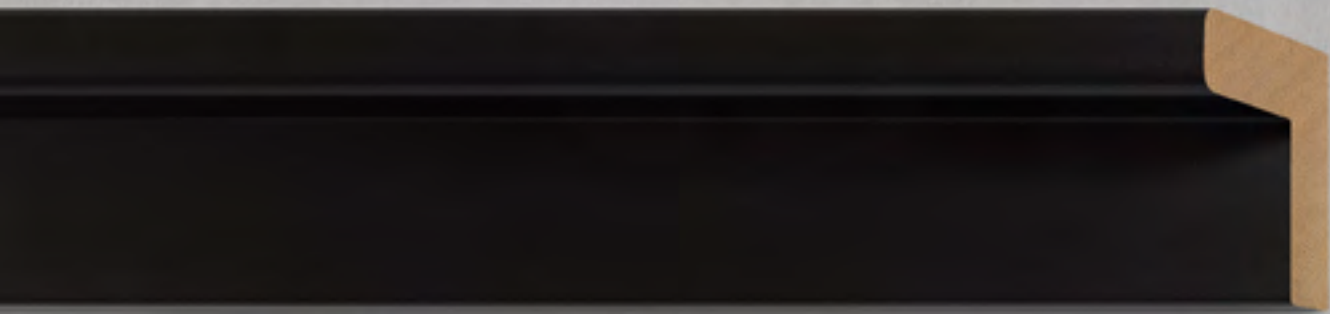

560 / s91

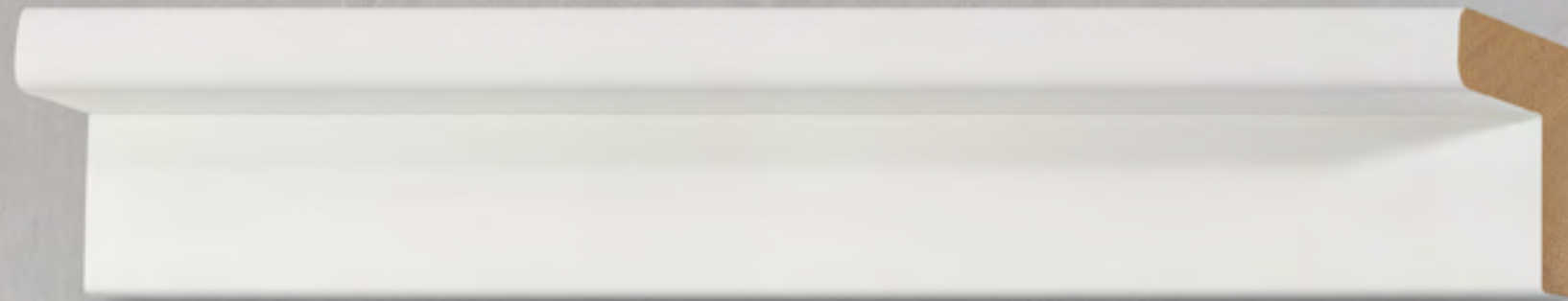

560 / 40

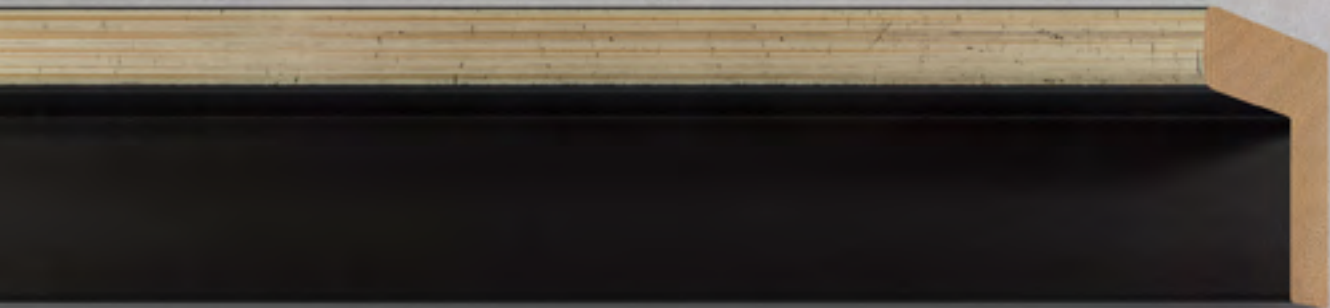

560 / 716

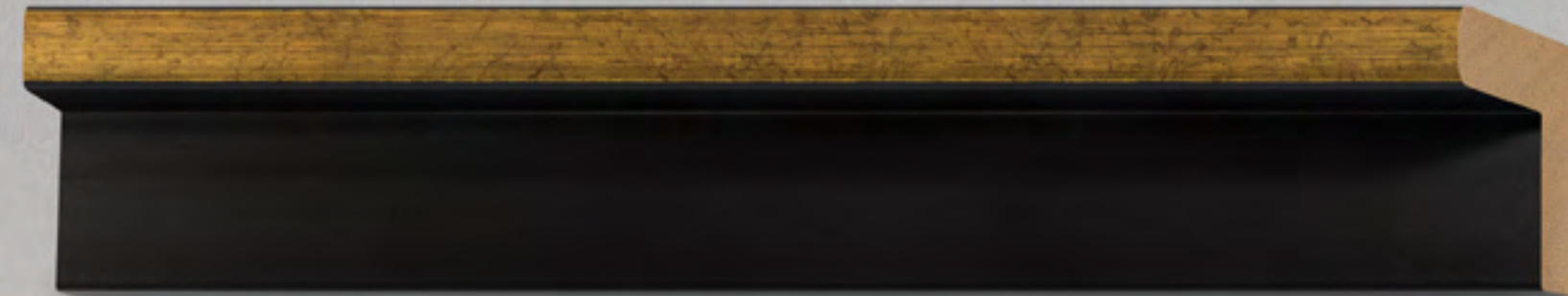

560 / 715

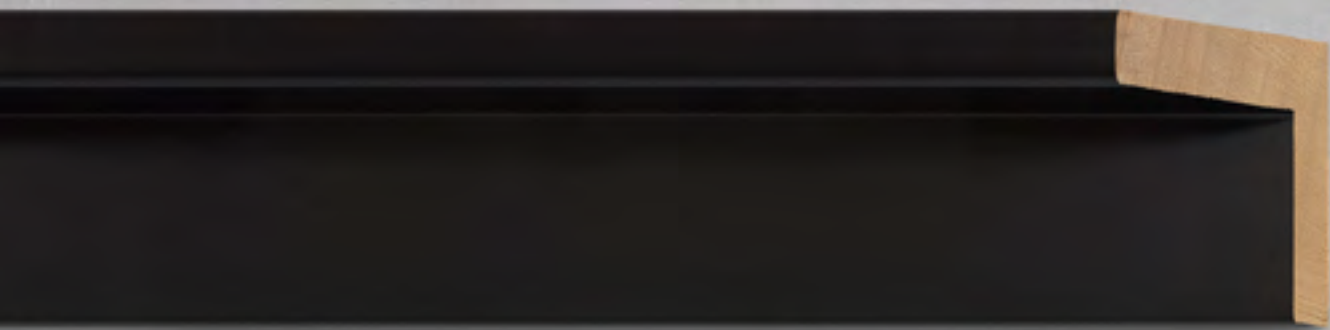

570 / s91

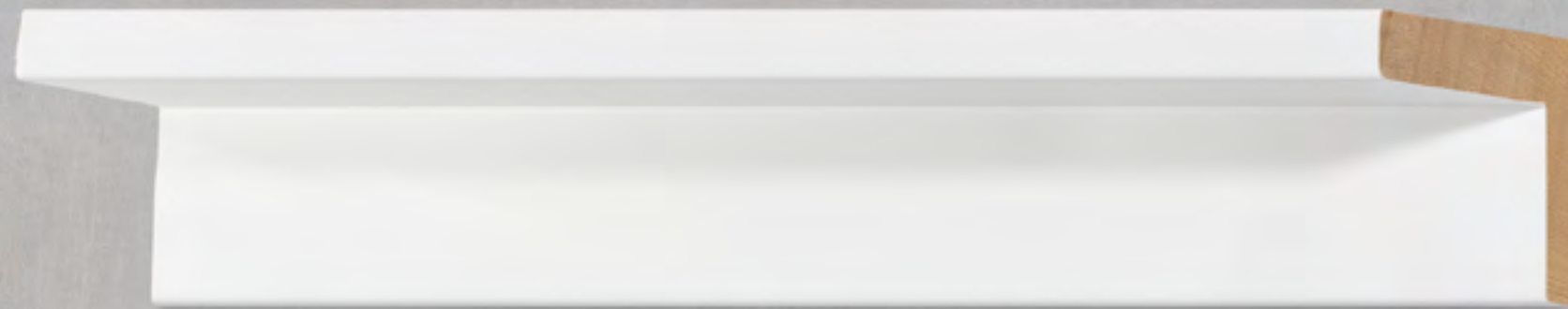

570 / 40



640 / 716

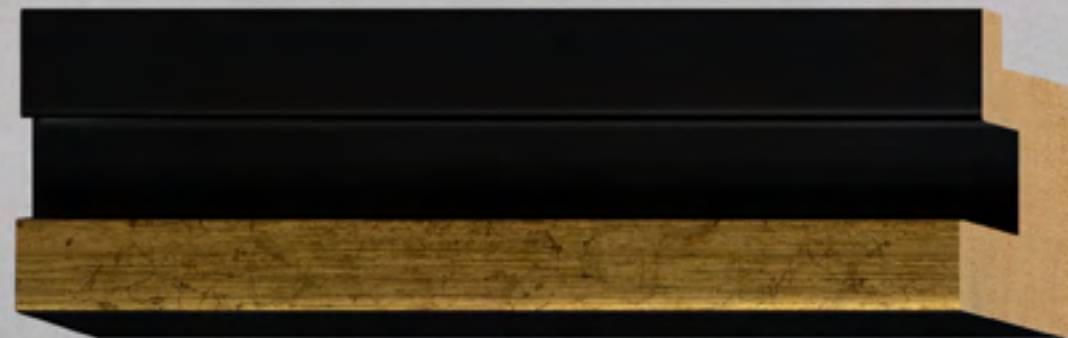

640 / 715



640 / 40

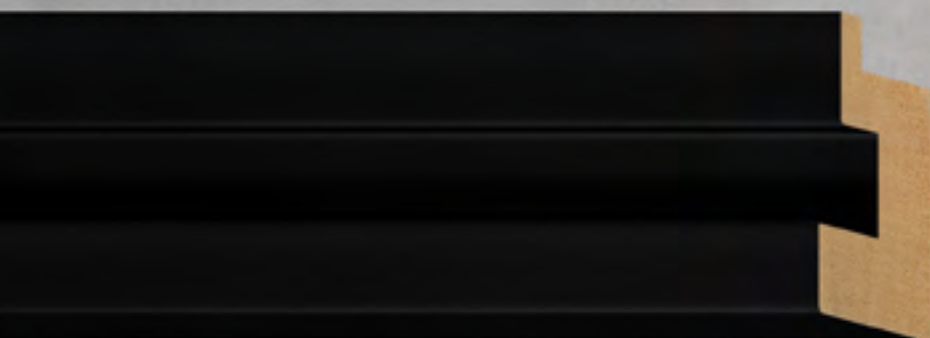

640 / M91



640 / 816



640 / 815

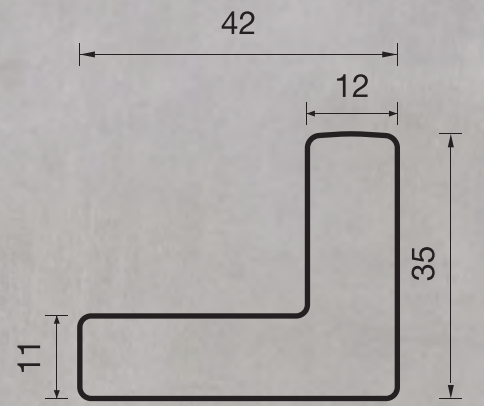

Art. 560

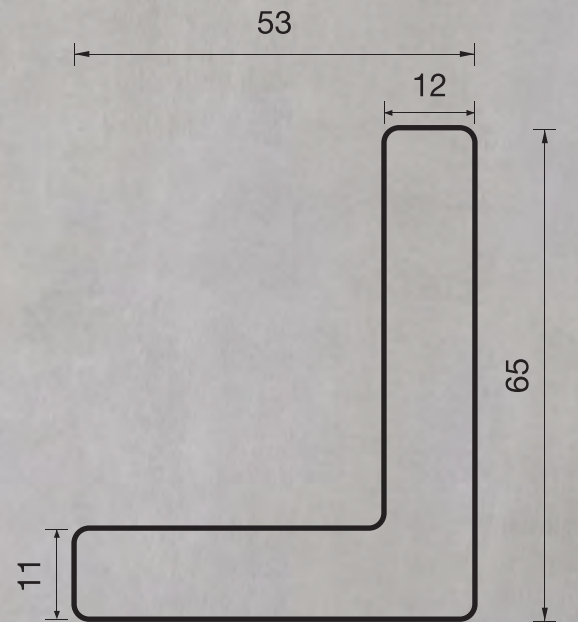

Art. 570

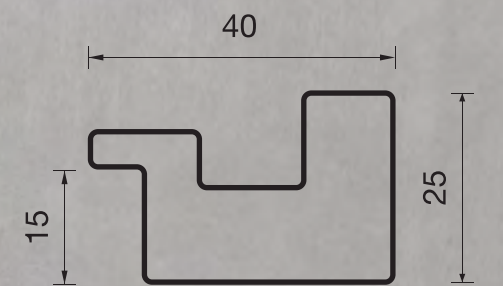

Art. 640



179 / 81



179 / 91



179 / 65



179 / 66



Art. 179

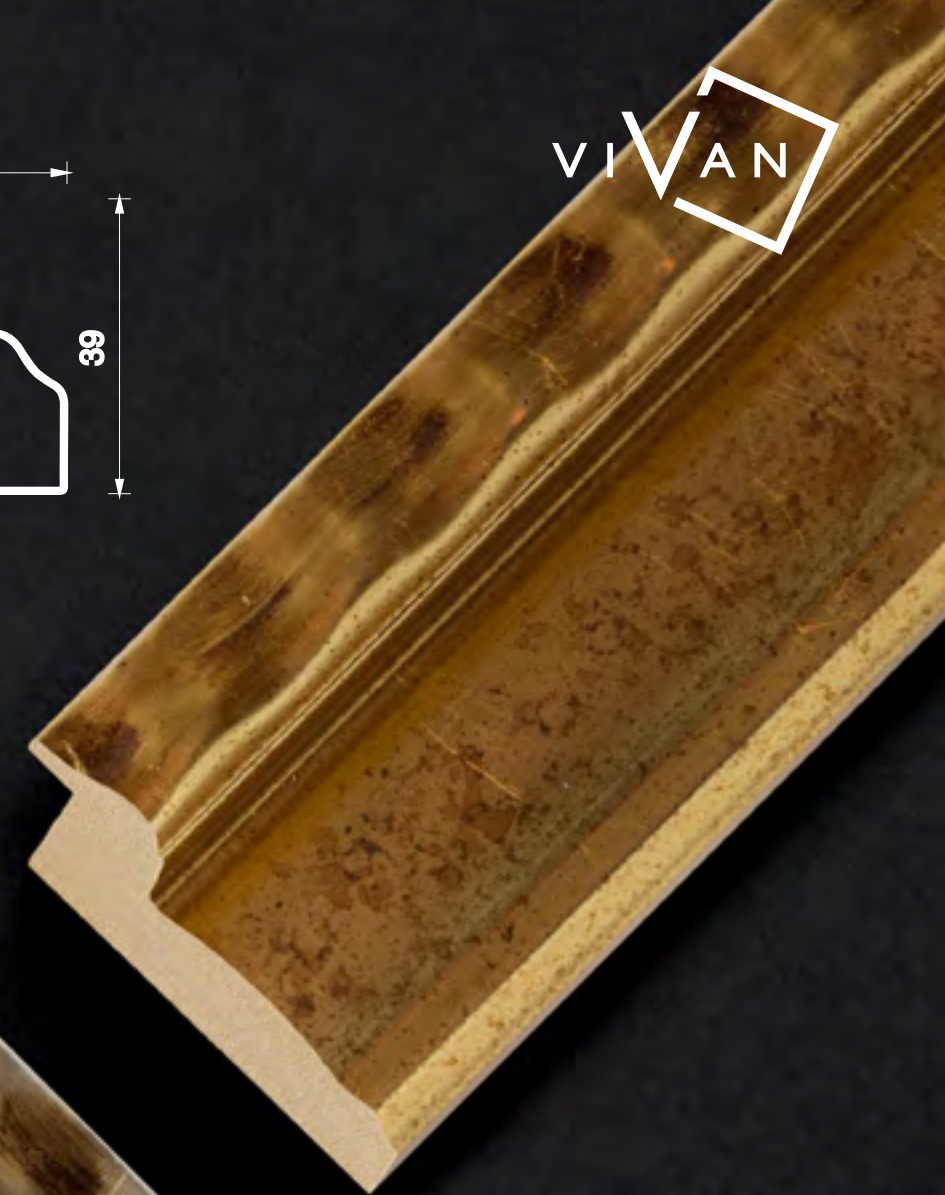

191 / 715

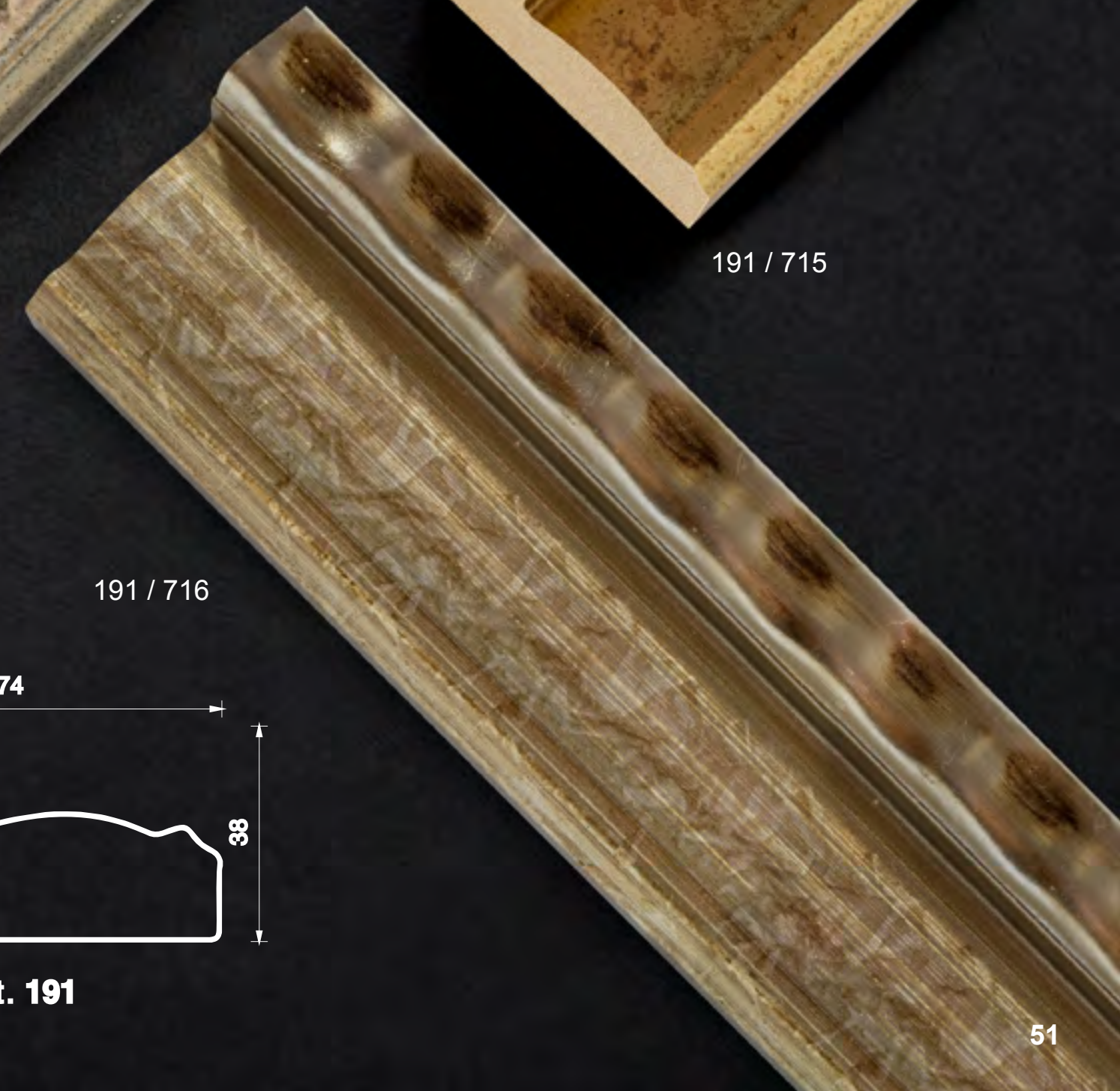

191 / 716

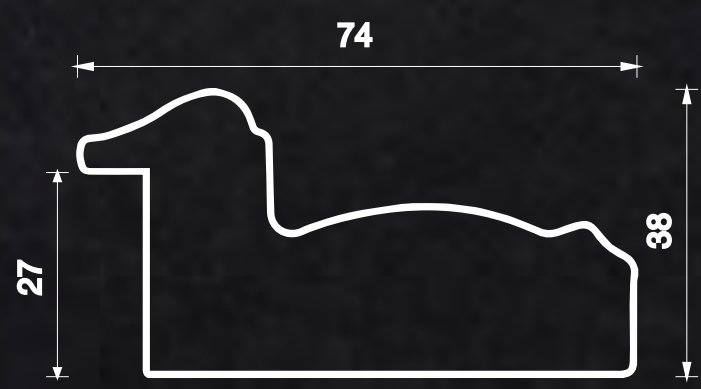

Art. 191



1201 / 65



1205 / 65



Art. 1205



1201 / 66



1205 / 66



1201 / 200



1205 / 200



Art. 1201



17 / 66



17 / 65

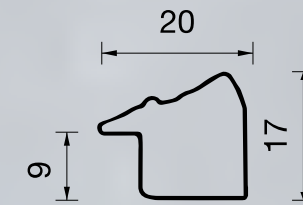

Art. 17



86 / 62



86 / 61



86 / 31

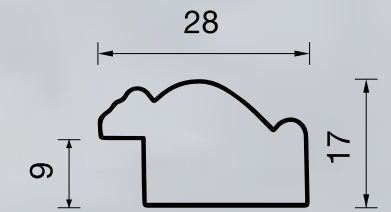

Art. 86



1301 / 62



1301 / 61

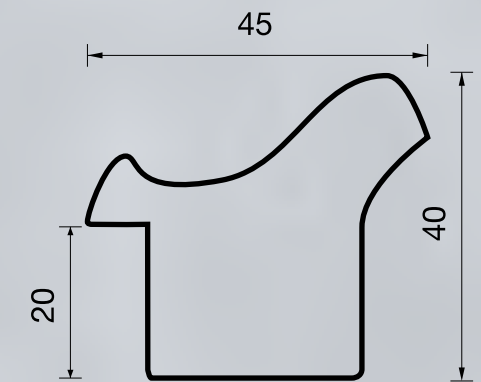

Art. 1301



1600 / 66



1600 / 65

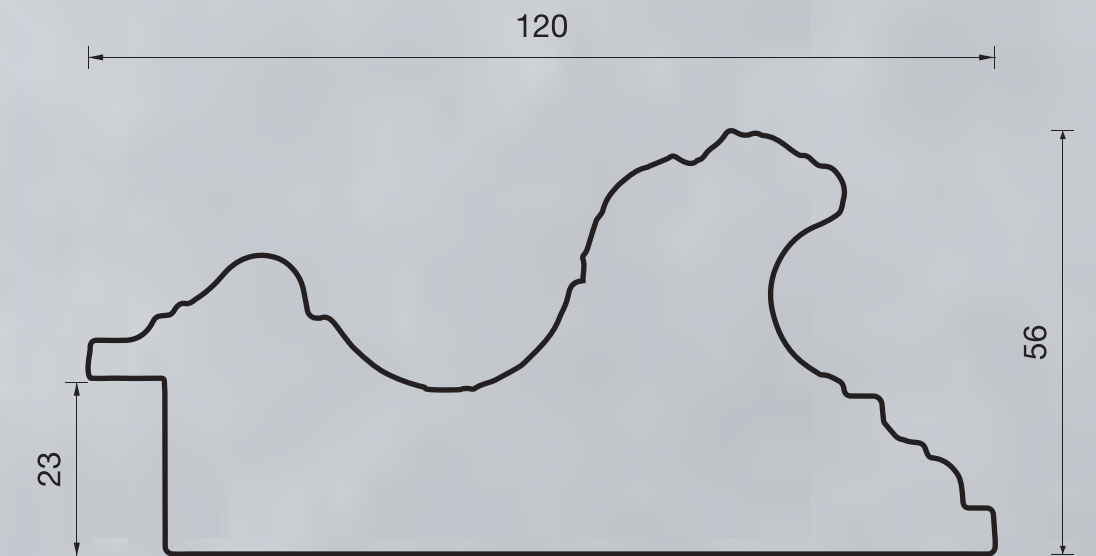

Art. 1600



64 / 7



64 / 6A



64 / 5A



64 / 31



64 / 9

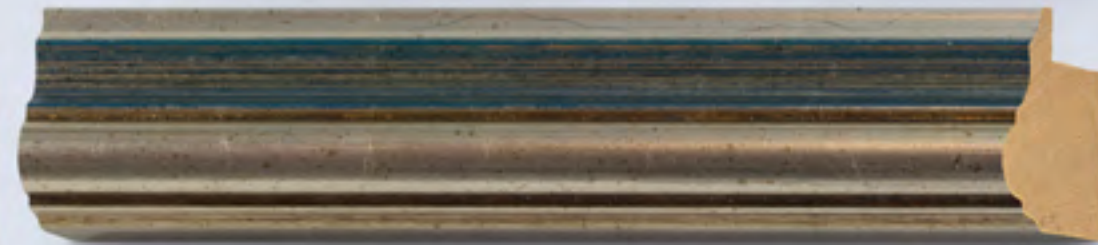

64 / 8



65 / 6A



65 / 5A



82 / 6A



82 / 5A



95 / 30



95 / 6A



95 / 5A

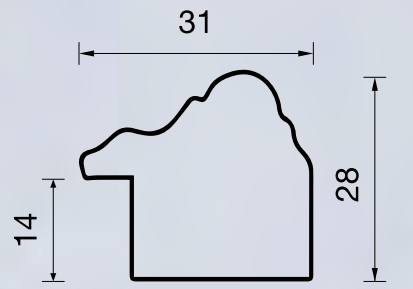

Art. 64

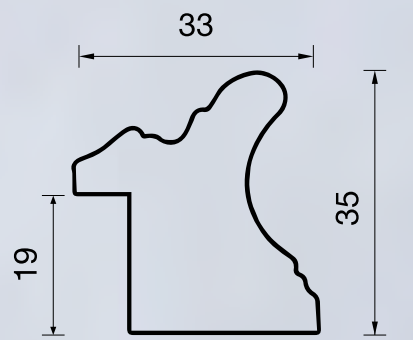

Art. 65

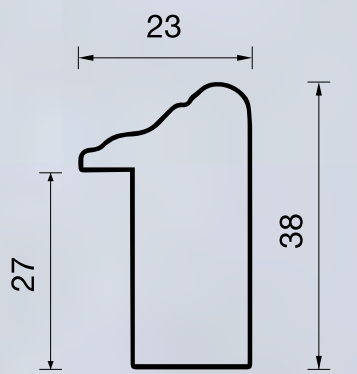

Art. 82

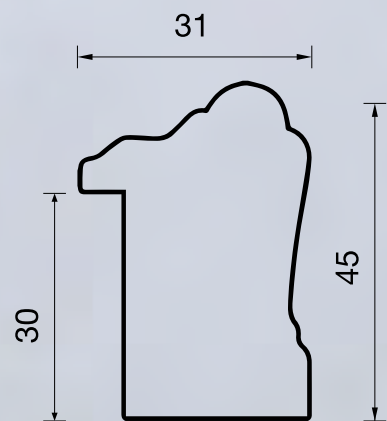

Art. 95



11 / 62



11 / 61



11 / 2



11 / 1



11 / 79



11 / 77



11 / 75

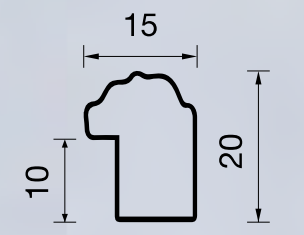

Art. 11



39 / 31



39 / 6A



39 / 5A

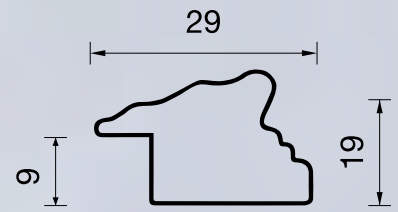

Art. 39



52 / 4



52 / 3

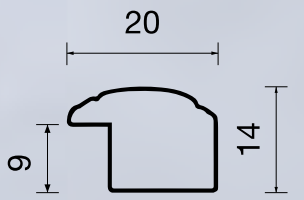

Art. 52



53 / 6A



53 / 5A

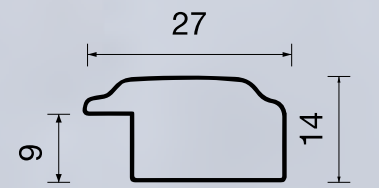

Art. 53



71 / 13



71 / 4

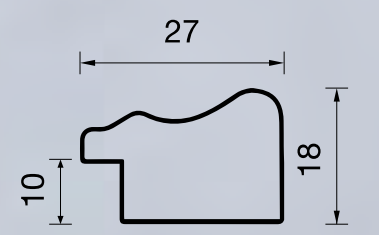

Art. 71



71 / 91



71 / 31



41 / 31

41 / 61

41 / 62

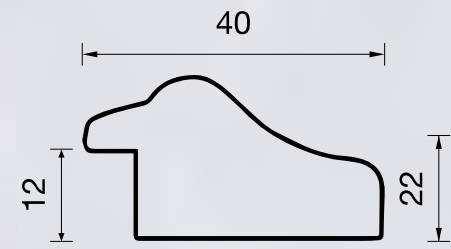

Art. 41

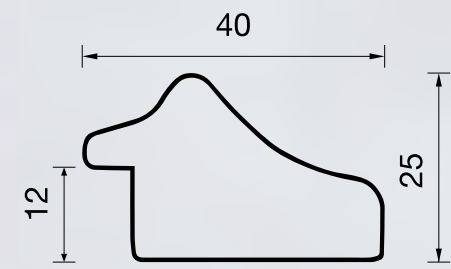

Art. 47

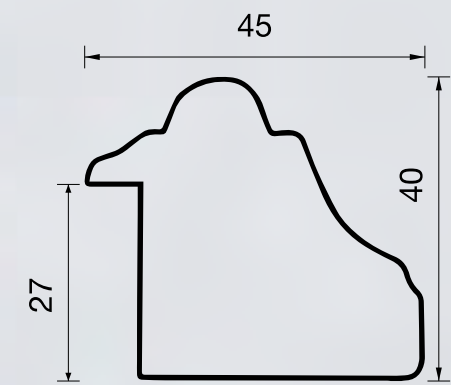

Art. 51



51 / 65



51 / 66

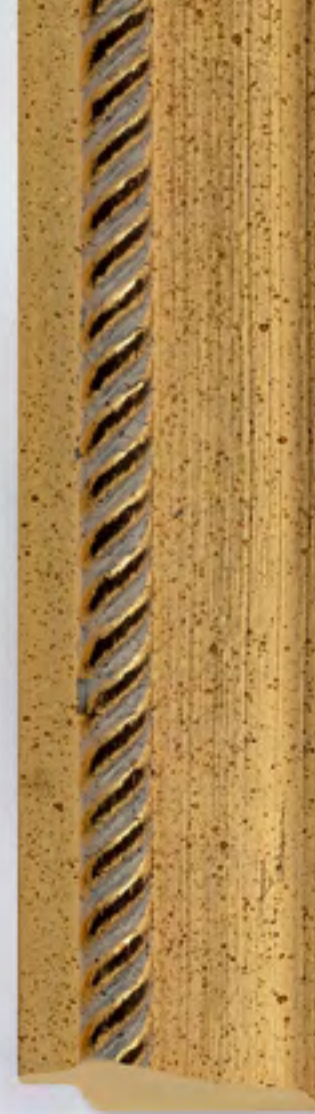

47 / 65

47 / 66

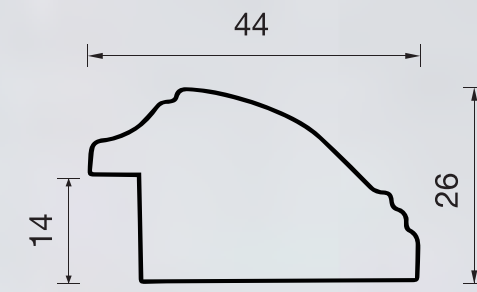

Art. 93

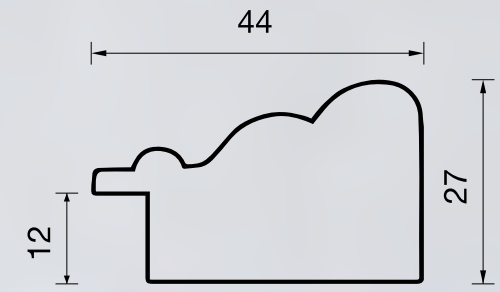

Art. 99



93 / 31



99 / 4



99 / 13



99 / 91



109 / 3



109 / 4



109 / 111



109 / 105



109 / 104



109 / 108



109 / 106



98 / 5A



98 / 6A



98 / 7



98 / 8

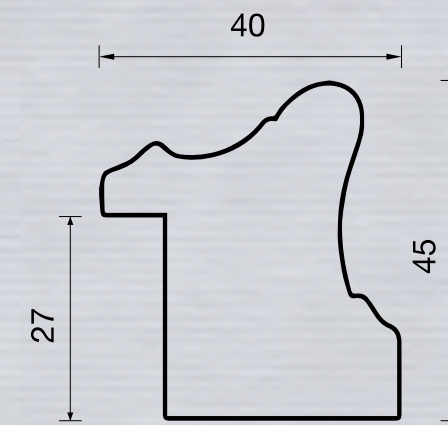

Art. 98

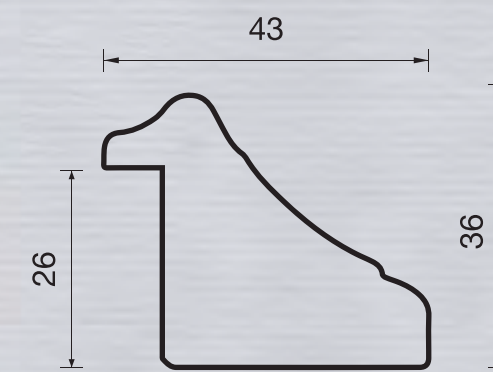

Art. 109



98 / 9



98 / 15



98 / 30



111 / 6A



111 / 5A



111 / 2



111 / 1



113 / 48



113 / 47



113 / 31

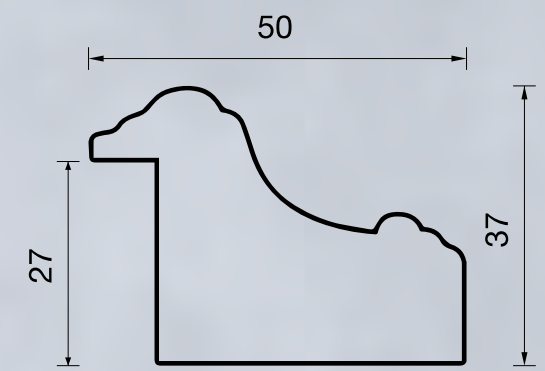

Art. 111



113 / 66



113 / 65

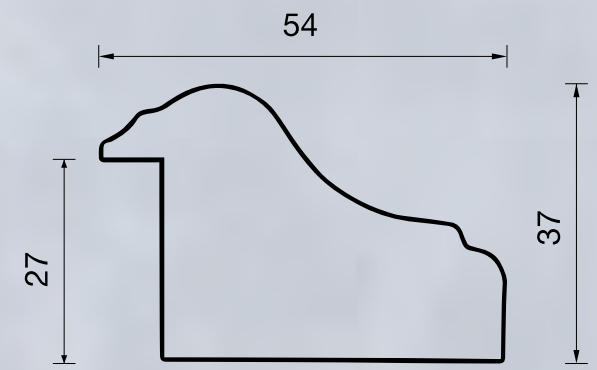

Art. 113



113 / 108



113 / 106



113 / 105

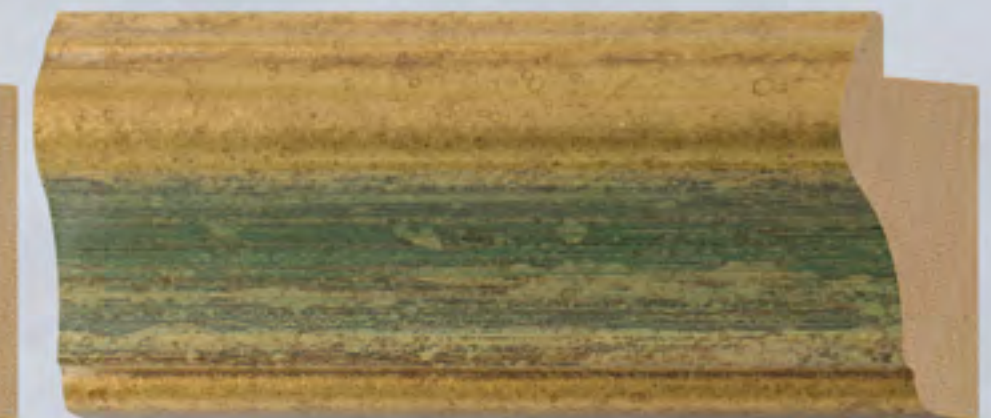

113 / 104



106 / 5A



106 / 6A



106 / 65



159 / 5A



159 / 6A



159 / 31



106 / 66



106 / 81



106 / 82



159 / 104



159 / 105



159 / 106

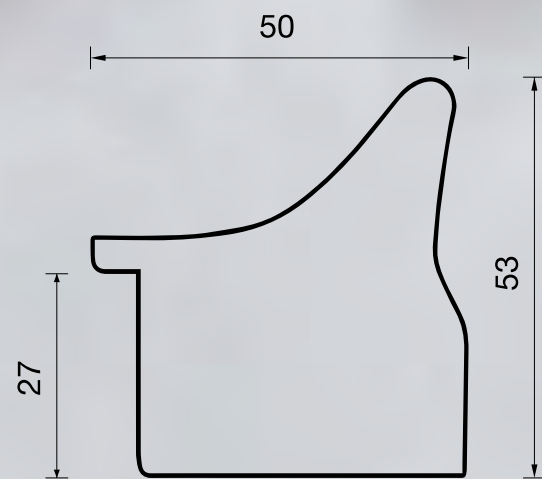

Art. 106

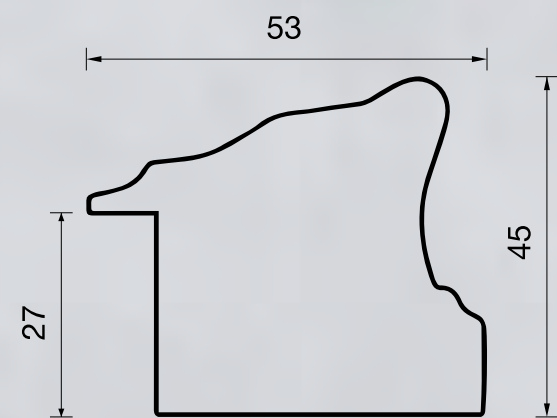

Art. 159



159 / 108



29 / 61



29 / 62



29 / 65



29 / 66

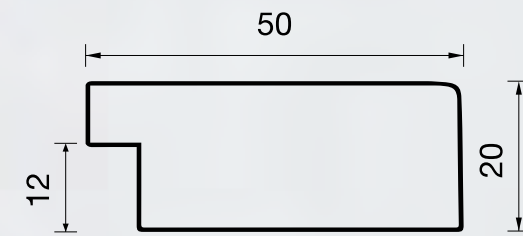

Art. 29

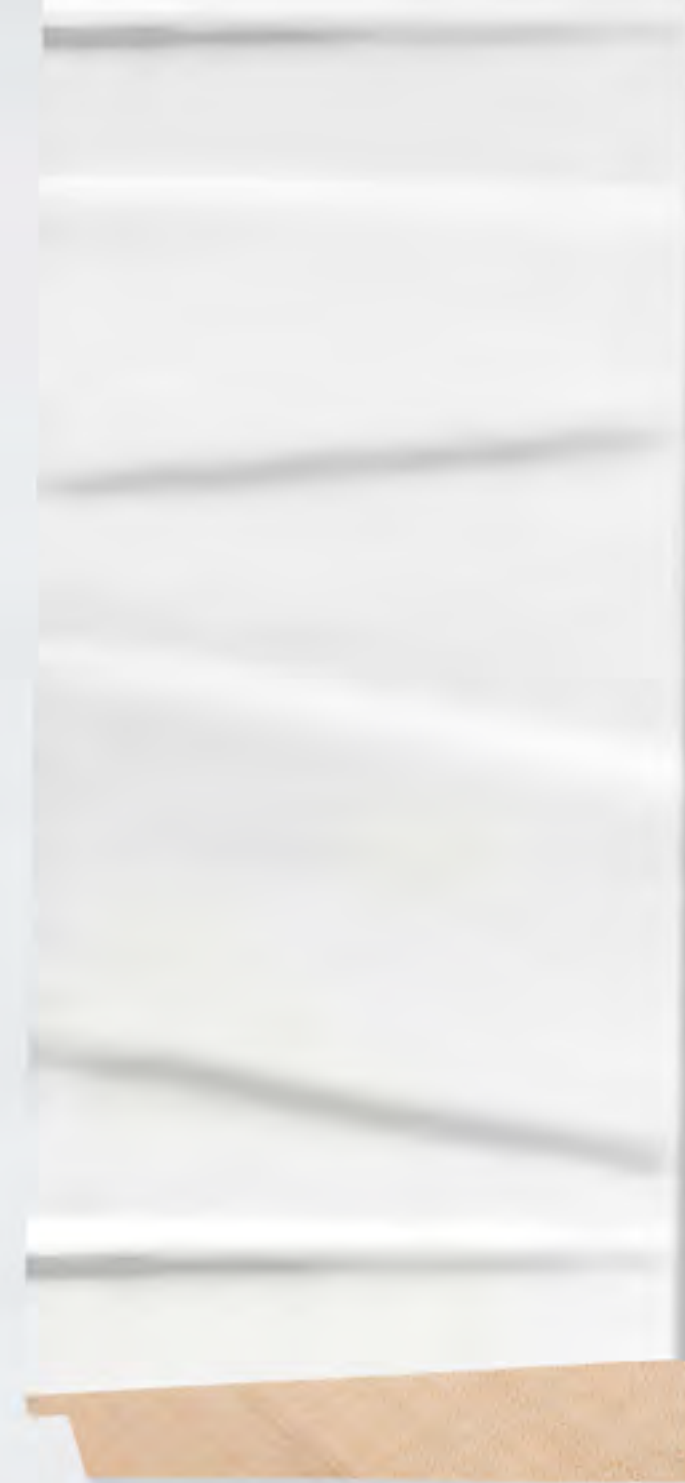

900 / 81



900 / 91

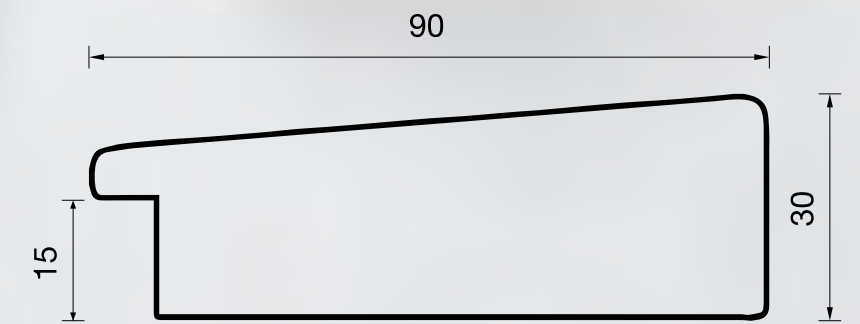

Art. 900



320 / 39



320 / 4



320 / 3



321 / 39



321 / 4



321 / 3

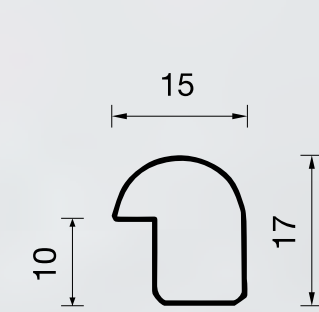

Art. 320

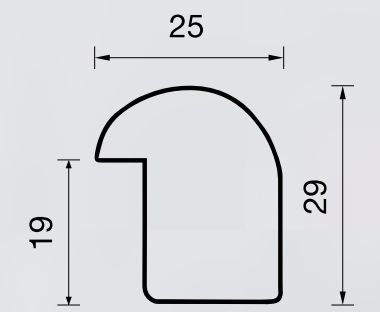

Art. 321



168 / 4



168 / 3

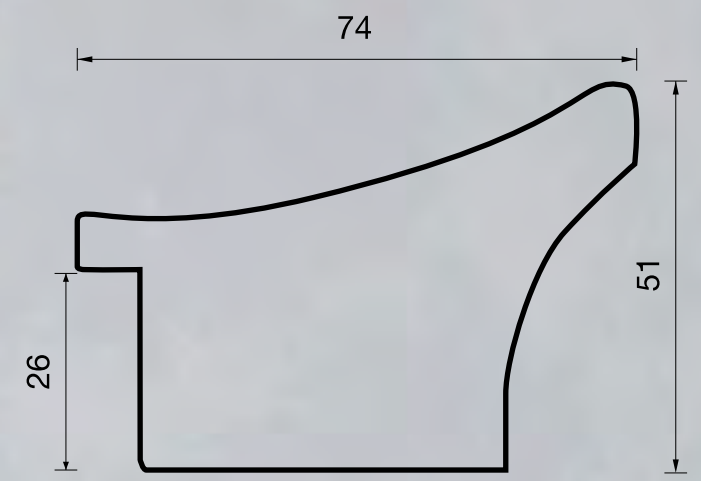

Art. 168



168 / M91



168 / 40



181 / 4



181 / 3

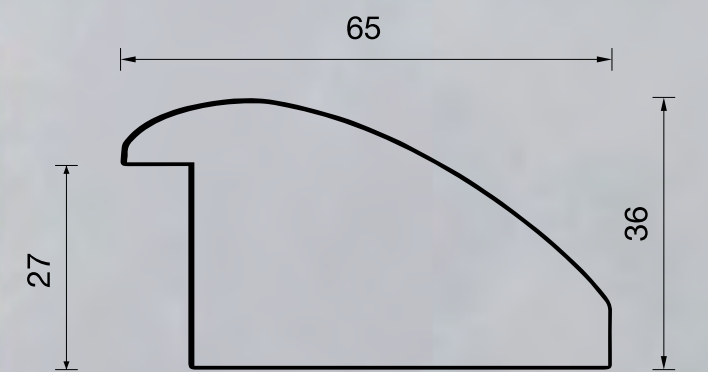

Art. 181

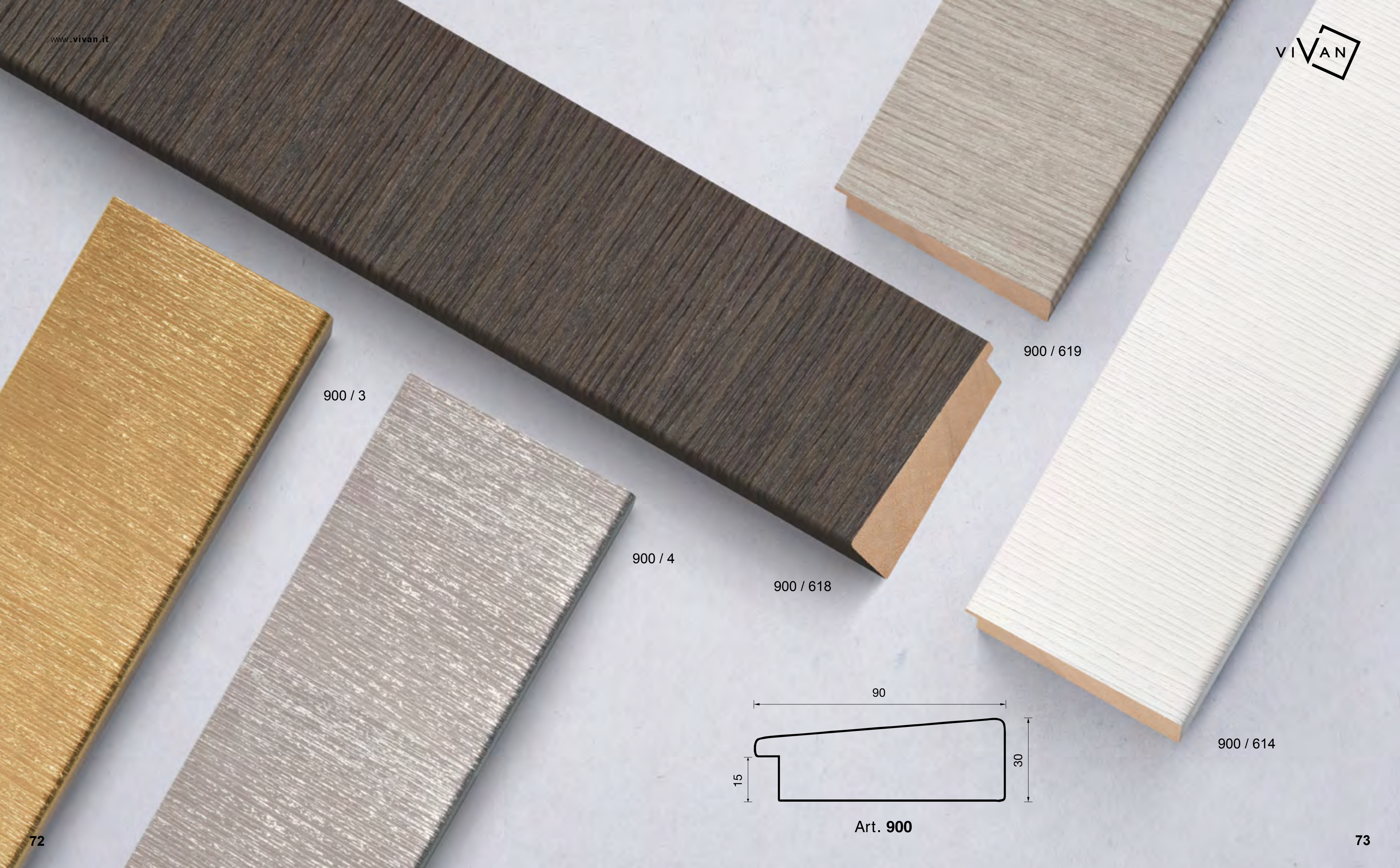

900 / 3

900 / 4

900 / 618

900 / 619

900 / 614

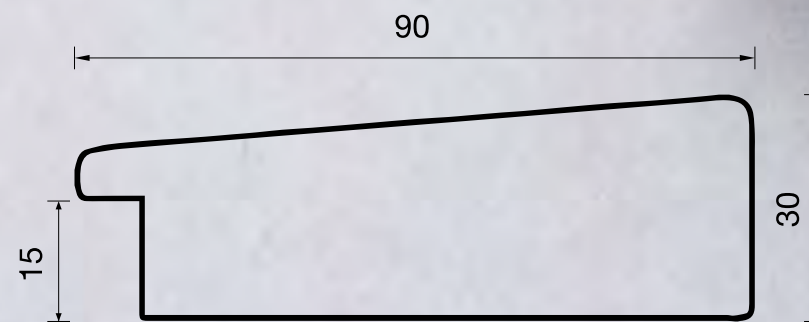

Art. 900



167 / 66



167 / 65

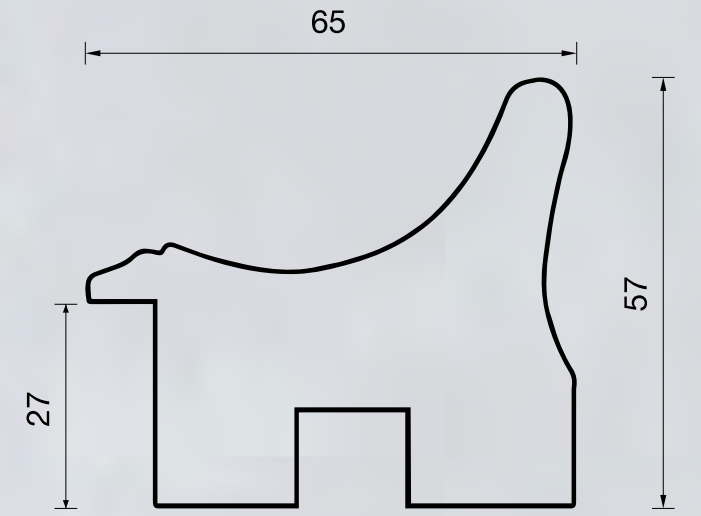

Art. 167



178 / 71



178 / 70



178 / 69



178 / 65



178 / 72

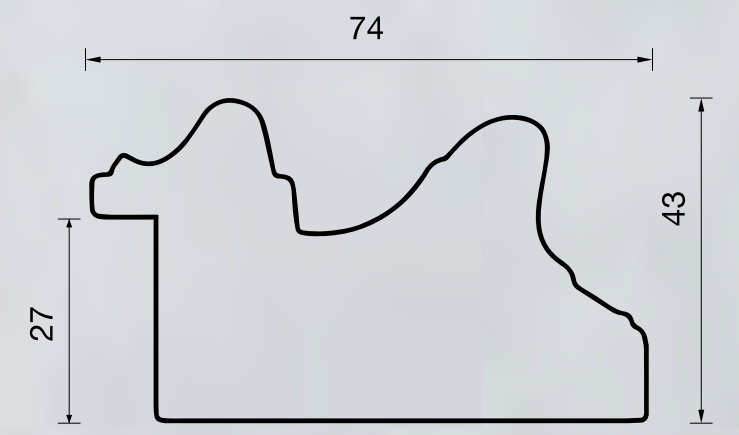

Art. 178



100 / 6A



100 / 5A



100s / 66



100s / 65



700 / 65



700 / 66

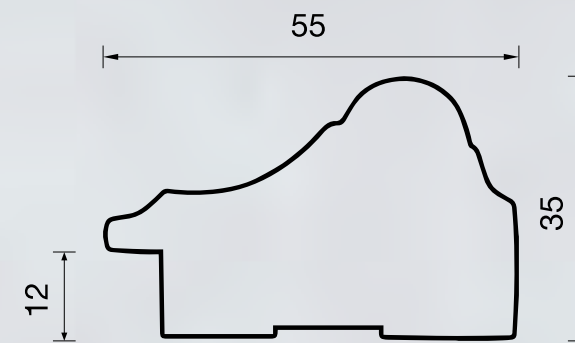

Art. 100

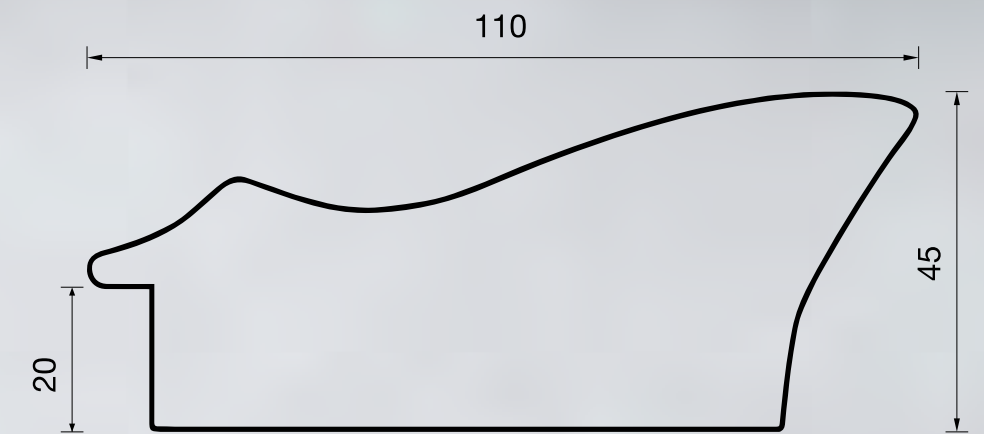

Art. 700



920 / 207



920 / 200



930 / 207



930 / 200

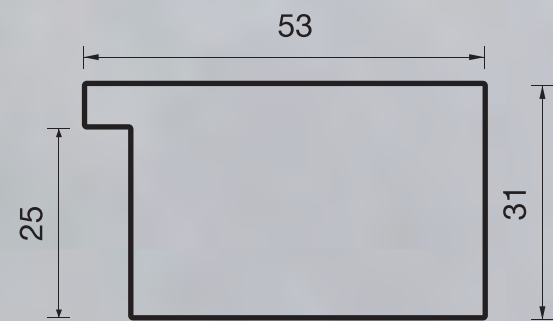

Art. 920

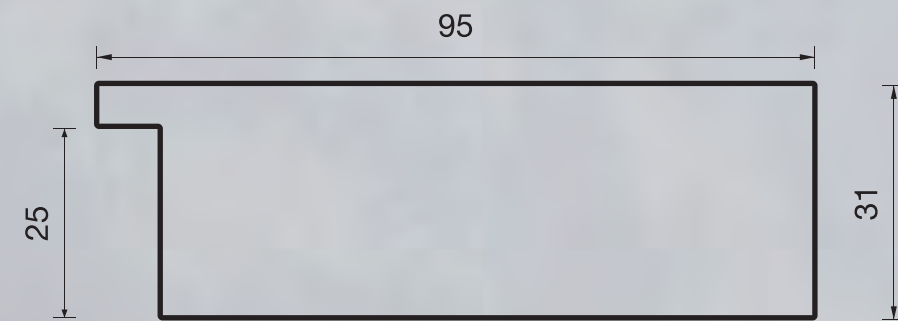

Art. 930



505 / 400



505 / 401



505 / 402

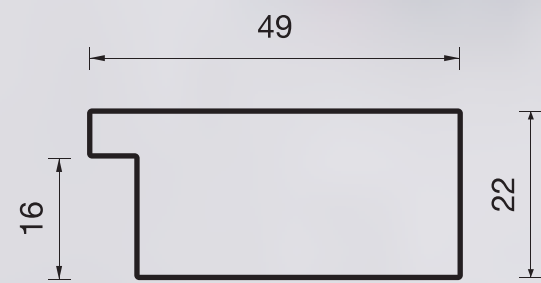

Art. 505

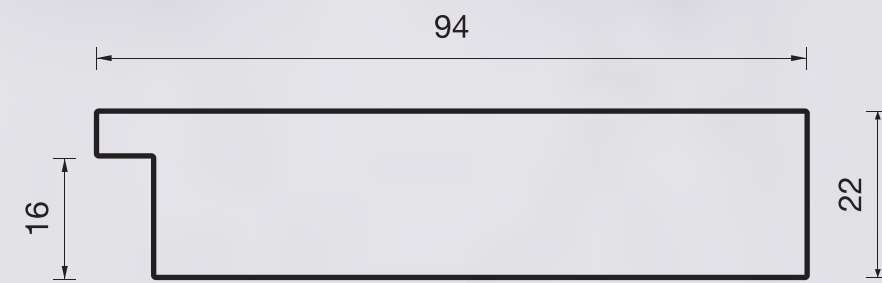

Art. 805



805 / 400



805 / 402



505 / 403



505 / 404



805 / 404



805 / 401



805 / 403



P35PT/40 P35PTFA P35PTFB P35PTFO



P35FAS P35FBS P35FOS



P35S/181 P35FAPAR P35FOPAR



P45FAS P45FBS P45FOS



P45FAPAR P45FOPAR



145 / 161 145 / 162



145 / 166 145 / 167 145 / 168

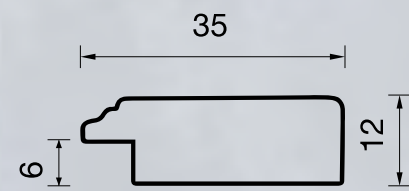

Art. P35PT

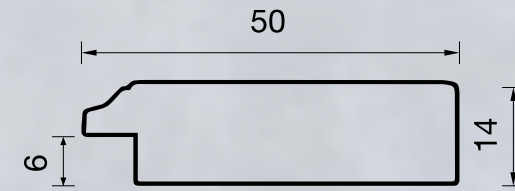

Art. P5

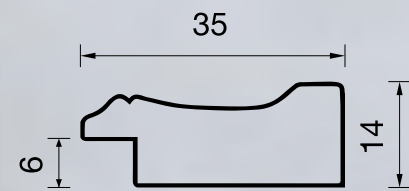

Art. P35S

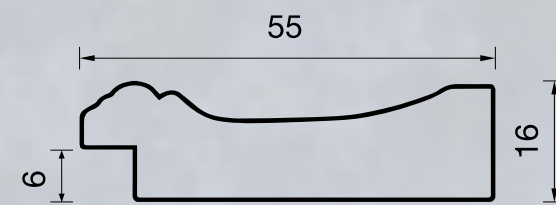

Art. P55



Art. P45S

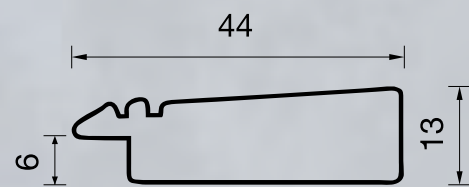

Art. 145

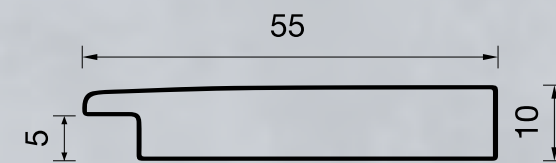

Art. P55/81-82



P5FA



P5/40



P5FO

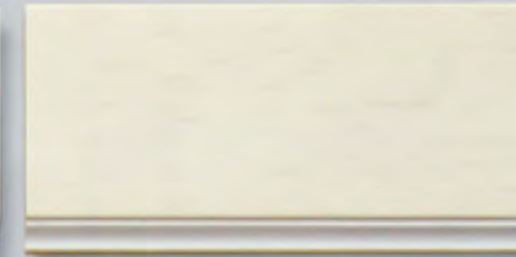

P5FB



P55FA



P55FO



P55FOPAR



P55FAPAR



P55/181

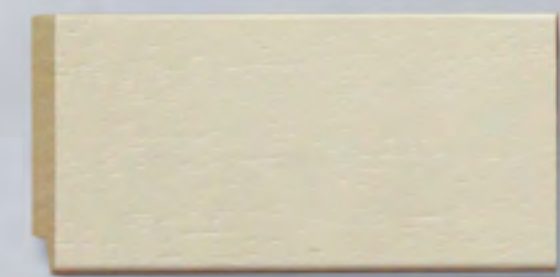

P55/82



P55/81



RIG3,5X1,6 - RIG4,5X1,6 - RIG5,5X1,6

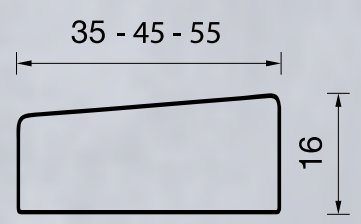

Art. **RIG**



RIG2,5X1 - RIG4X1

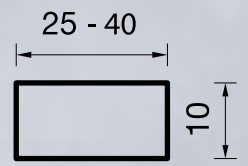

Art. **RIG**



P35T - P45T - P55T - P65T - P75T

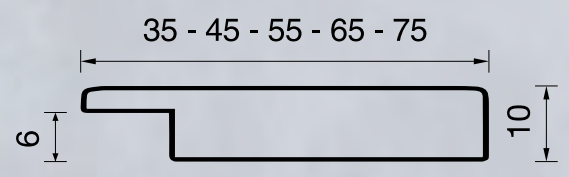

Art. **PASSE-PARTOUT**



TEL4,5X1,6 - TEL5,5X1,6

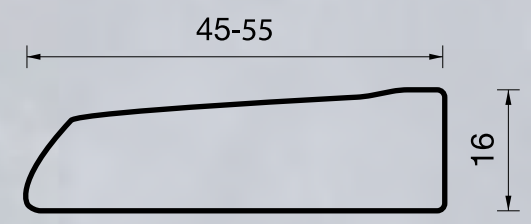

Art. **TEL**



G3,5X4,5

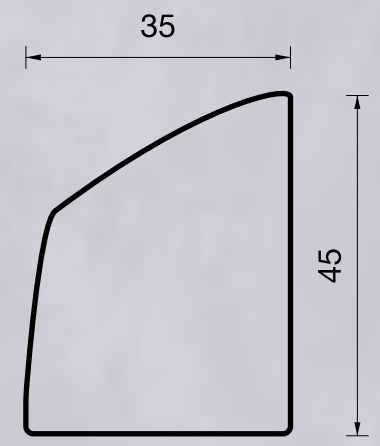

Art. **G3,5X4,5**

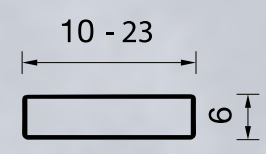

Art. **DIST**

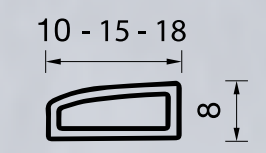

Art. **DIST**

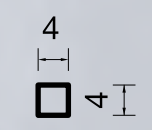

Art. **FV**

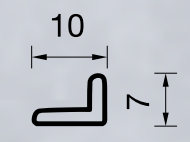

Art. **SLIP**



DIST / 00G



DIST / 3G



DIST / 4G

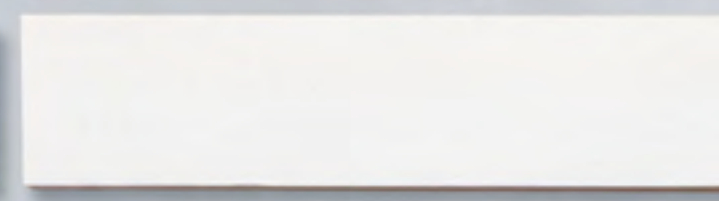

DIST / 40G



DIST / 96G



DISTS91G



DIST / 00P



DIST / 3P



DIST / 4P

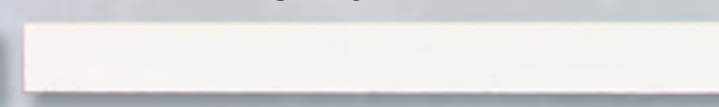

DIST / 40P



DIST / 96P

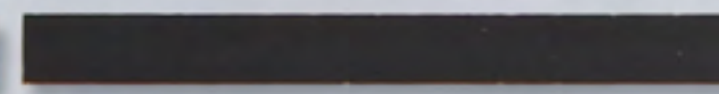

DISTS91P



DIST18 / 3



DIST18 / 4



DIST18 / 40



DIST18 / 91



FV / 00



FV / 3



FV / 4



FV / 39

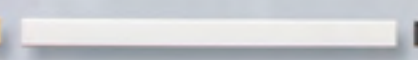

FV / 40



FV / S91



SLIP / F400



SLIP / F401



SLIP / F402

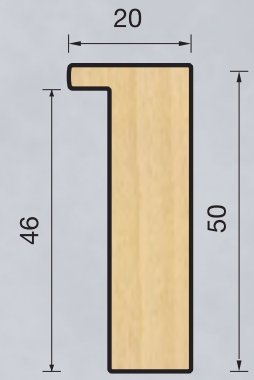

0006 / 96
LEGNO/WOOD:
AYOUS

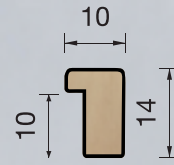

10 / 96
LEGNO/WOOD:
TIGLIO/LIME

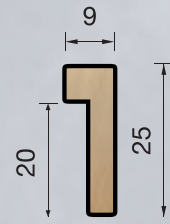

12 / 96
LEGNO/WOOD:
TIGLIO/LIME

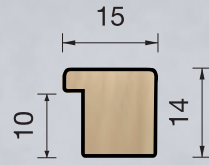

15 / 96
LEGNO/WOOD:
TIGLIO/LIME

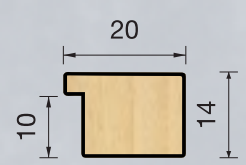

20 / 96
LEGNO/WOOD:
AYOUS

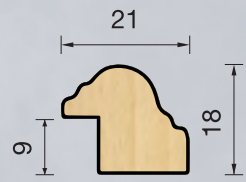

24 / 96
LEGNO/WOOD:
AYOUS

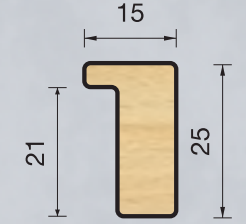

303 / 96
LEGNO/WOOD:
AYOUS

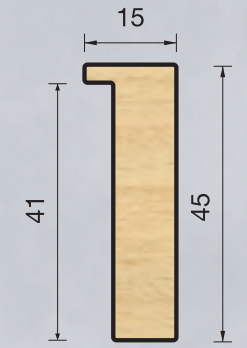

305 / 96
LEGNO/WOOD:
AYOUS

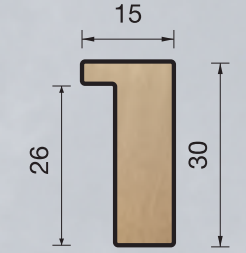

306 / 96
LEGNO/WOOD:
TIGLIO/LIME

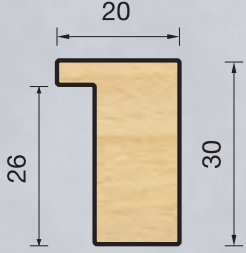

307 / 96
LEGNO/WOOD:
AYOUS

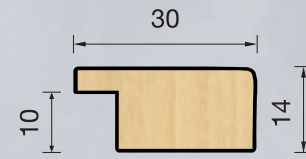

30 / 96
LEGNO/WOOD:
AYOUS

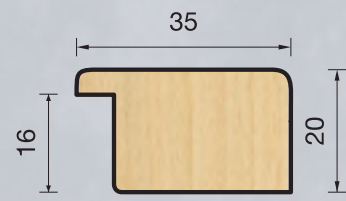

32 / 96
LEGNO/WOOD:
AYOUS

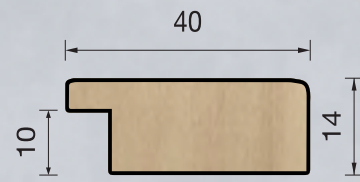

40 / 96
LEGNO/WOOD:
TIGLIO/LIME

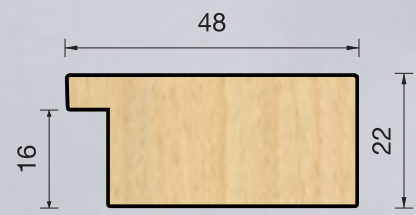

48 / 96
LEGNO/WOOD:
AYOUS

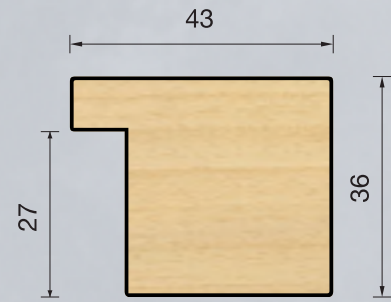

309 / 96
LEGNO/WOOD:
AYOUS

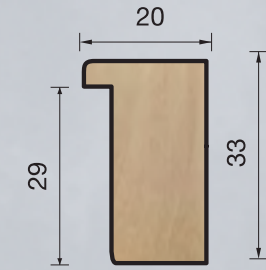

310 / 96
LEGNO/WOOD:
TIGLIO/LIME

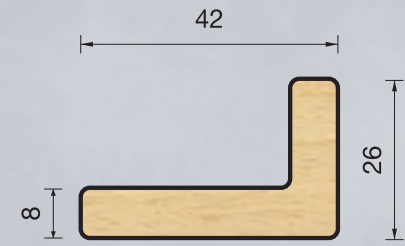

460 / 96
LEGNO/WOOD:
AYOUS

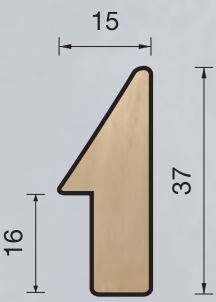

470 / 96
LEGNO/WOOD:
TIGLIO/LIME

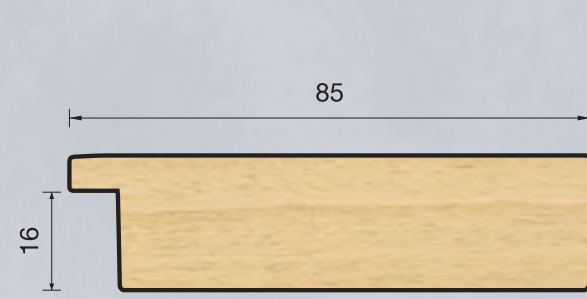

85 / 96
LEGNO/WOOD:
AYOUS

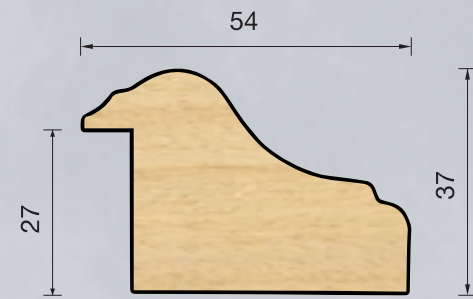

113 / 96
LEGNO/WOOD:
AYOUS

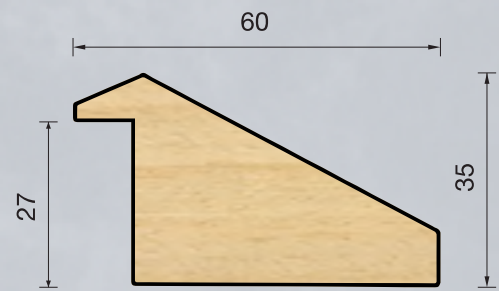

163 / 96
LEGNO/WOOD:
AYOUS

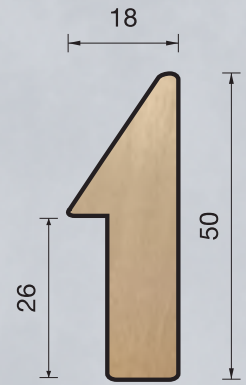

490 / 96
LEGNO/WOOD:
TIGLIO/LIME

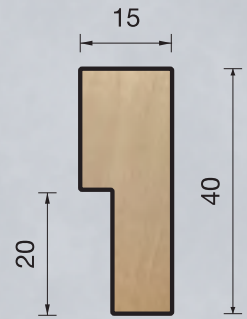

500 / 96
LEGNO/WOOD:
TIGLIO/LIME

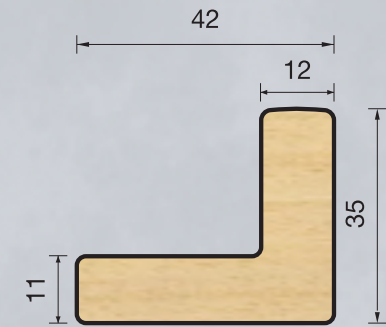

560 / 96
LEGNO/WOOD:
AYOUS

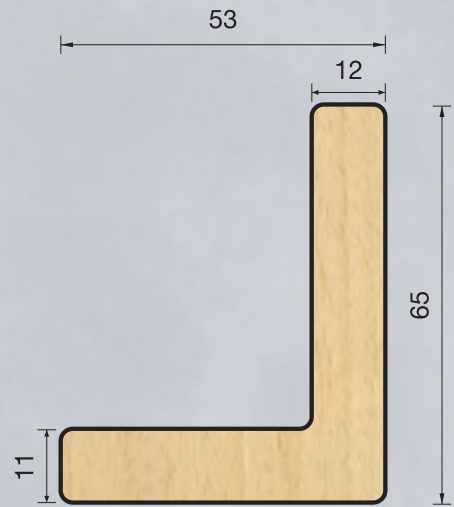

570 / 96
LEGNO/WOOD:
AYOUS

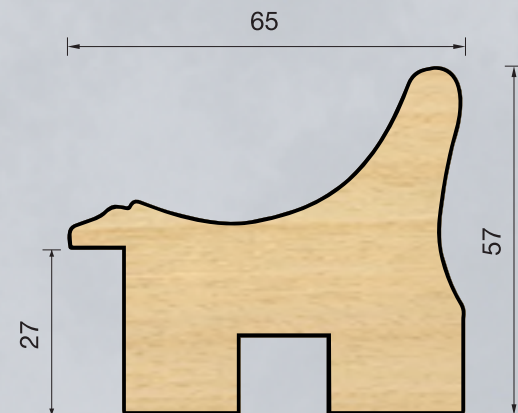

167 / 96
LEGNO/WOOD:
AYOUS

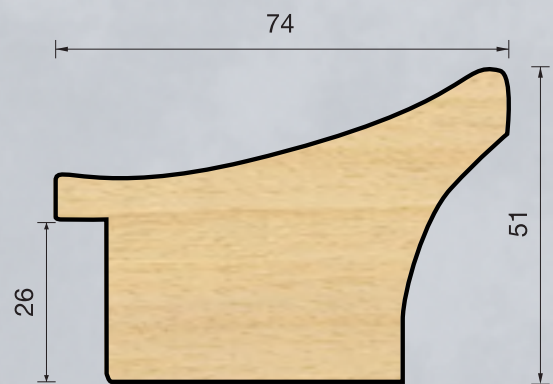

168 / 96
LEGNO/WOOD:
AYOUS

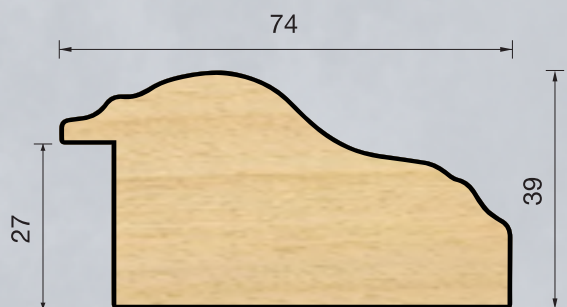

179 / 96
LEGNO/WOOD:
AYOUS

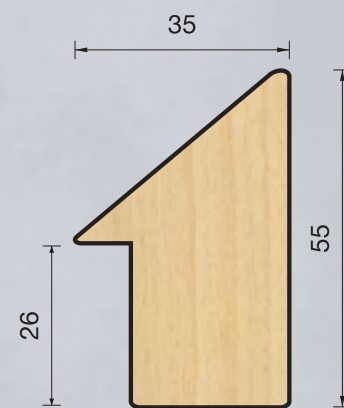

590 / 96
LEGNO/WOOD:
AYOUS

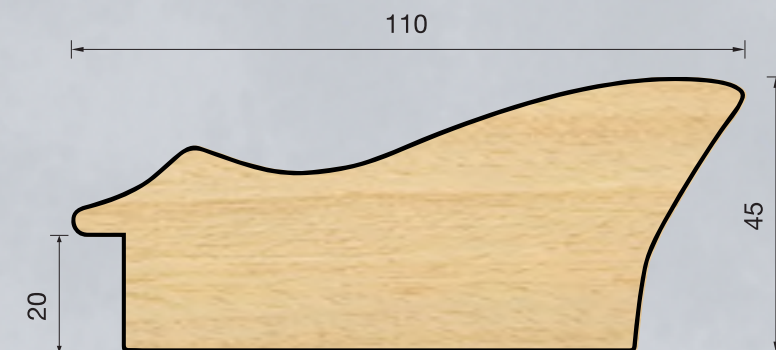



700 / 96
LEGNO/WOOD:
AYOUS



Via Enrico Mattei, 15
31045, Motta di Livenza (TV), ITALY

Tel: +39 0422 860 418
Fax: +39 0422 861 645

vivan@vivan.it
www.vivan.it

   39 0422 860 418